

GE Consumer & Industrial

Technical Service Guide

October 2007

Profile Bottom Mount Refrigerators

PDCF1NBW
PDCS1NBW
PDSF5NBW
PDSS5NBW
PFCF1NFW
PFCF1NJW
PFCS1NFW
PFCS1NJW
PFIC1NFW
PFSF5NFW
PFSF5NJW
PFSS5NFW
PFSS5NJW

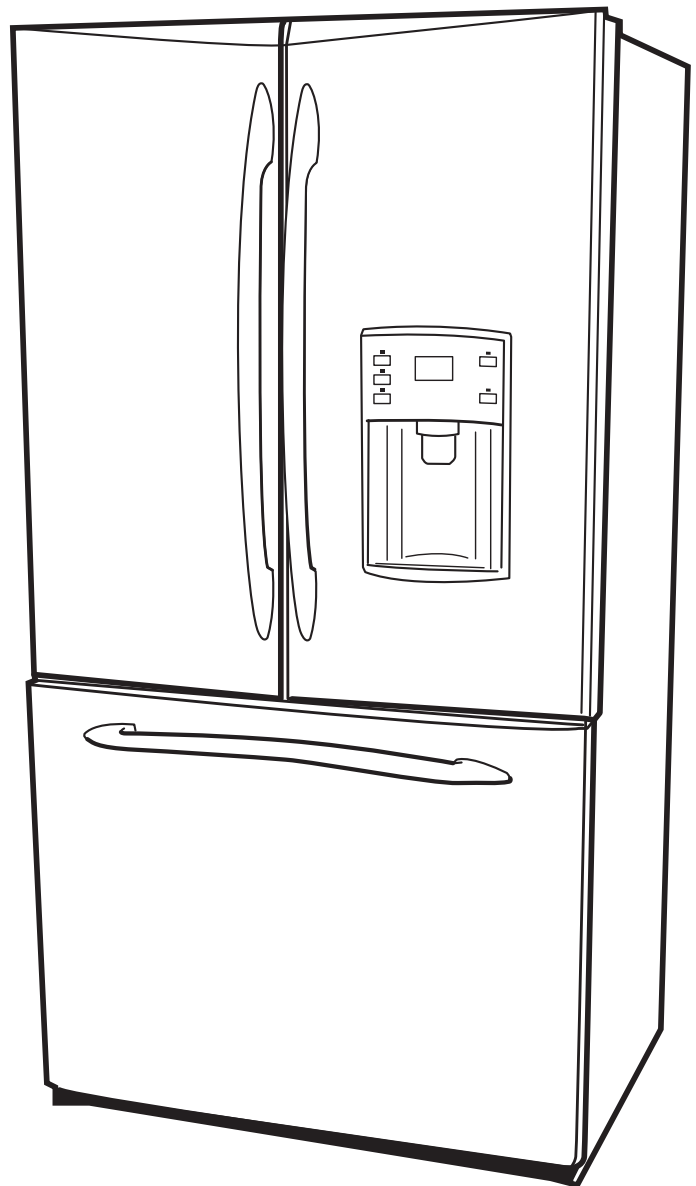

31-9154



GE Appliances
General Electric Company
Louisville, Kentucky 40225



IMPORTANT SAFETY NOTICE

The information in this service guide is intended for use by individuals possessing adequate backgrounds of electrical, electronic, and mechanical experience. Any attempt to repair a major appliance may result in personal injury and property damage. The manufacturer or seller cannot be responsible for the interpretation of this information, nor can it assume any liability in connection with its use.

WARNING

To avoid personal injury, disconnect power before servicing this product. If electrical power is required for diagnosis or test purposes, disconnect the power immediately after performing the necessary checks.

RECONNECT ALL GROUNDING DEVICES

If grounding wires, screws, straps, clips, nuts, or washers used to complete a path to ground are removed for service, they must be returned to their original position and properly fastened.

GE Consumer & Industrial
Technical Service Guide
Copyright © 2007

All rights reserved. This service guide may not be reproduced in whole or in part in any form without written permission from the General Electric Company.

Table of Contents

Airflow.....	32
Anti-Tip Floor Bracket (on 21 ft. models).....	9
Articulating Door Mullion (French Door Models)	49
Components.....	33
Components Locator Views.....	26
Condenser Fan.....	39
Control Board Connector Locator.....	28
Control Diagnostics Using the Temperature Display.....	53
Control Features.....	20
Defrost Cycle.....	25
Defrost Heater.....	46
Dispenser Lock.....	25
Drawer Closure Mechanisms	52
EMI Filter.....	52
Evacuation and Charging Procedure	31
Evaporator	43
Evaporator Fan	38
Freezer Drawer Handle	15
Freezer Shelves and Baskets.....	36
Fresh Food and Freezer Light Thermostats.....	38
Fresh Food Crispers and Pans	35
Fresh Food Damper	48
Fresh Food Door Handle	12
Fresh Food Shelves and Bins.....	33
Icemaker Fill Tube Heater	46
Installation	7
Introduction.....	4
Inverter	41
Inverter Compressor.....	42
Liner Protection Mode.....	25
Nomenclature.....	5
Refrigeration Components.....	30
Refrigeration System	30
Removing and Installing Double Doors (Some Models)	16
Removing and Installing the Freezer Drawer (Some Models)	18
Replacing Evaporator Using the Brazing Method.....	47
Return Duct Heaters.....	46
Reversing the Door Swing (Single Door Refrigerator Models only).....	13
Schematic.....	55
Technical Data.....	6
Thermistors	37
Troubleshooting.....	53
Warranty	56
Water Dispenser and Interface.....	50

Introduction

*The new Profile Bottom Mount Refrigerators have the following features:

- Available in 21 and 25 cubic foot capacity with fresh food single or french door configurations.
- Icemaker ready or factory installed icemaker.
- French door models feature optional filtered external water dispenser.
- Two coil water tanks provide added storage volume with increased surface area for quick temperature recovery.
- ENERGY STAR®, variable speed inverter compressor and fans for all models.
- Up front, electronic touch temperature controls with digital temperature display.
- An external "air" thermistor changes the control setting based on ambient condition to keep the fresh food and freezer at the correct temperature.
- Damper/air inlet assembly in the fresh food section creates more usable space on the top shelf.
- An articulating door mullion attached to the right side door (french door models), provides a movable center mullion that maximizes access to the fresh food compartment.
- Two self closing freezer drawer cam and lever mechanisms that automatically pull the drawer shut when it's within 1 inch of the closed position.
- Anti-tip kit will be required for 21 cu. ft. models.
- BrightSpace™ Interior with GE Reveal™ Lighting.
- Available in white, black, bisque, or stainless finish.
- Trim kits are available that allow adding decorator or wood panels to match kitchen cabinets.
- New nomenclature, (PDSF5NBWABB instead of PDSF25NBWABB). Cubic foot volume previously specified as 25, now shows as only 5.



* Features may vary by model.

Nomenclature

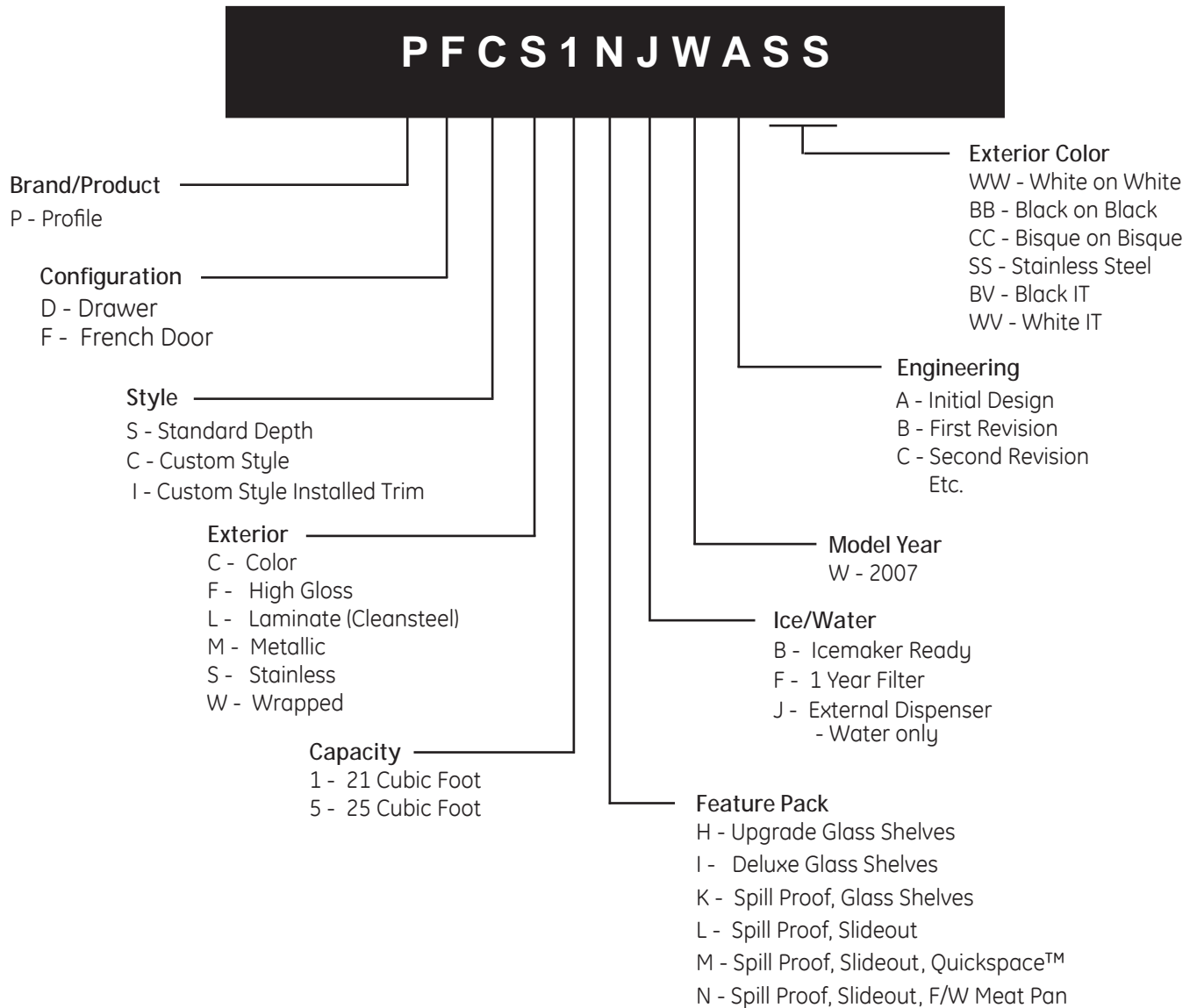

The nomenclature plate is located on the upper right wall of the fresh food compartment. It contains the following information:



- Model and Serial Number
- Minimum Installation Clearances
- Electrical Voltage, Frequency
- Maximum Amperage Rating
- Refrigerant Charge and Type

Serial Number

The first two numbers of the serial number identify the month and year of manufacture.

Example: **AM123456S** = January, 2007

A - JAN	2007 - M
D - FEB	2006 - L
F - MAR	2005 - H
G - APR	2004 - G
H - MAY	2003 - F
L - JUN	2002 - D
M - JUL	2001 - A
R - AUG	2000 - Z
S - SEP	1999 - V
T - OCT	1998 - T
V - NOV	1997 - S
Z - DEC	1996 - R

The letter designating the year repeats every 12 years.

Example:
T - 1974
T - 1986
T - 1998

Technical Data

DISCONNECT POWER CORD BEFORE SERVICING

IMPORTANT - RECONNECT ALL GROUNDING DEVICES

All parts of this appliance capable of conducting electrical current are grounded. If grounding wires, screws, straps, clips, nuts or washers used to complete a path to ground are removed for service, they must be returned to their original position and properly fastened.

IMPORTANT SAFETY NOTICE

This information is intended for use by individuals possessing adequate backgrounds of electrical, electronic and mechanical experience. Any attempt to repair a major appliance may result in personal injury and property damage. The manufacturer or seller cannot be responsible for the interpretation of this information, nor can it assume any liability in connection with its use.

ELECTRICAL SPECIFICATIONS

Temperature Control (Position 5).....	7-(-11)°F
Defrost Control (w/no door openings).....	96hrs @ 45 min
Thermistor kilo-ohm resistance.....	@0°F.....42.5
.....	@37°F.....14
.....	@77°F.....5
Overtemperature Thermostat	140-110°F
Defrost Thermistor.....	50°F
Electrical Rating: 115V AC 60 Hz	11.6 Amp
Maximum Current Leakage	0.75 mA
Maximum Ground Path Resistance	0.14 Ohms

NO LOAD PERFORMANCE

Control Position 5/5 and Ambient of 65°F to 90°F

Fresh Food, °F	34 to 40
Frozen Food, °F.....	-3 to 3F
Run Time, % @ 65°F.....	30 to 50
Run Time, % @ 90°F.....	50 to 80

AIR FLOW

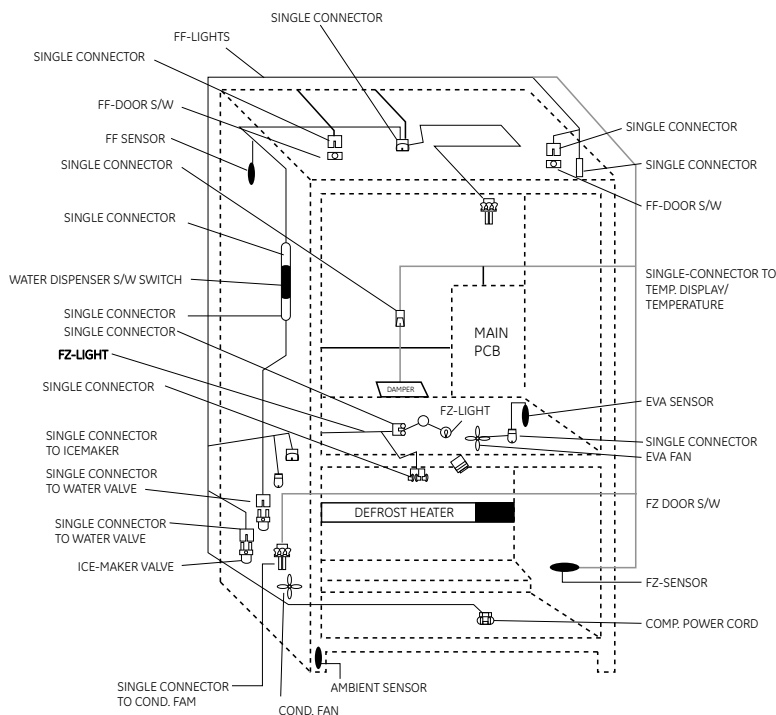
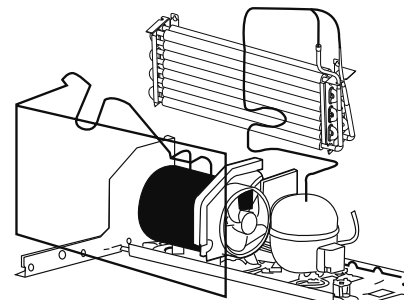
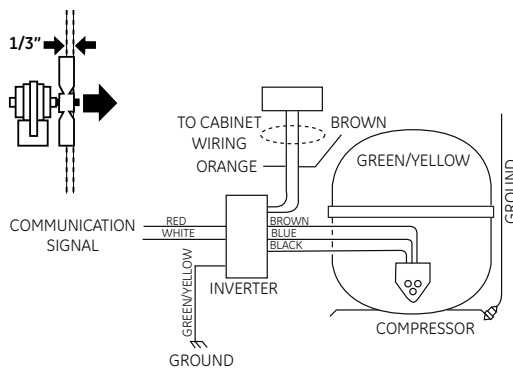
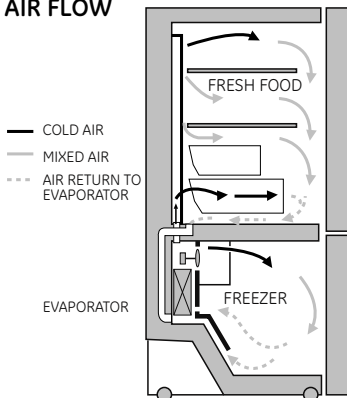

Installation

Trim Kits and Decorator Panels

For panel required models

Read these instructions completely and carefully.



Before You Begin

Some models are equipped with trim kits that allow you to install door panels. You can order pre-cut black or white decorator panels from GE Parts and Accessories, 800.626.2002, or you can add wood panels to match your kitchen cabinets.

Panels less than 1/4" (6 mm) thick

When installing wood panels less than 1/4" (6 mm) thick, you need to create a filler panel, such as 1/8" cardboard, that will fit between the face of the door and the wood panel. If you are installing the pre-cut decorator panels, pre-cut filler panels are included in the kit. The combined thickness of the decorator or wood panel and the filler panel should be 11/32" (8.7 mm) with the panel itself being no larger than 1/4" (6 mm).

Panels 1/4" thick or less

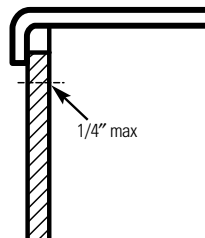

The handle and the top and bottom trim stand in front of the surface of the door, which requires that the filler be smaller in length and width than the panel. Use the guidelines below and tape the filler onto the back of the panel.

Left Fresh Food Door

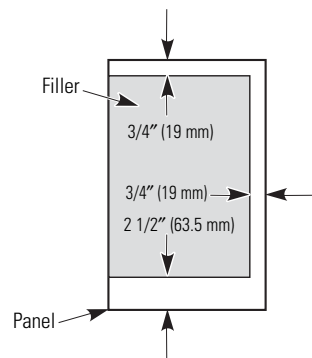

Right Fresh Food Door

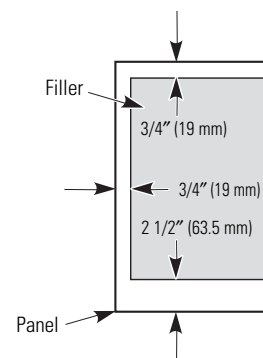

Freezer Door

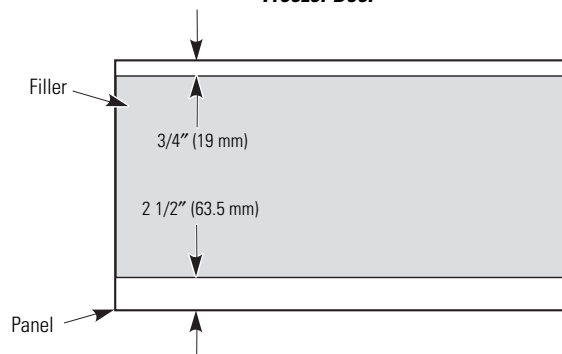

(Continued next page)

3/4" (19 mm) or Raised Panel

A raised panel design screwed or glued to a 1/4" (6 mm) thick backing, or a 3/4" (19 mm) routed board can be used. The raised portion of the panel must be fabricated to permit clearances of at least 2" (5.1 cm) from the handle side for fingertip clearance.

Panels thicker than 1/4" (6 mm), up to 3/4" (19 mm) max., will require that the outer 5/16" (8 mm) of panel perimeter be no thicker than 1/4" (6 mm).

Weight limitations for custom panels:

Fresh Food 10 lbs. (4.5 kg) max. for each door

Freezer Door 18 lbs. (8 kg) max.

Panels thicker than 1/4" (6 mm)

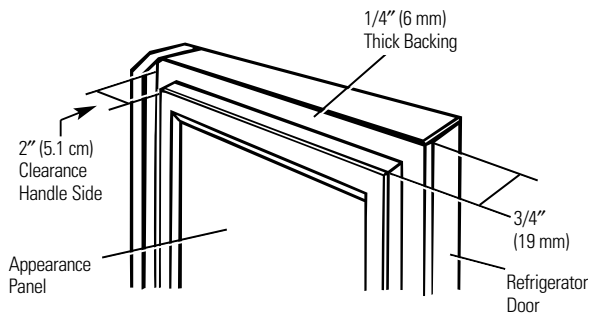
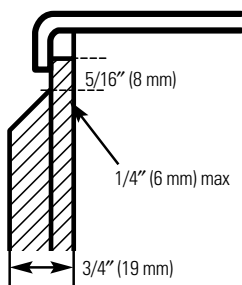

Dimensions for Custom Wood Panels

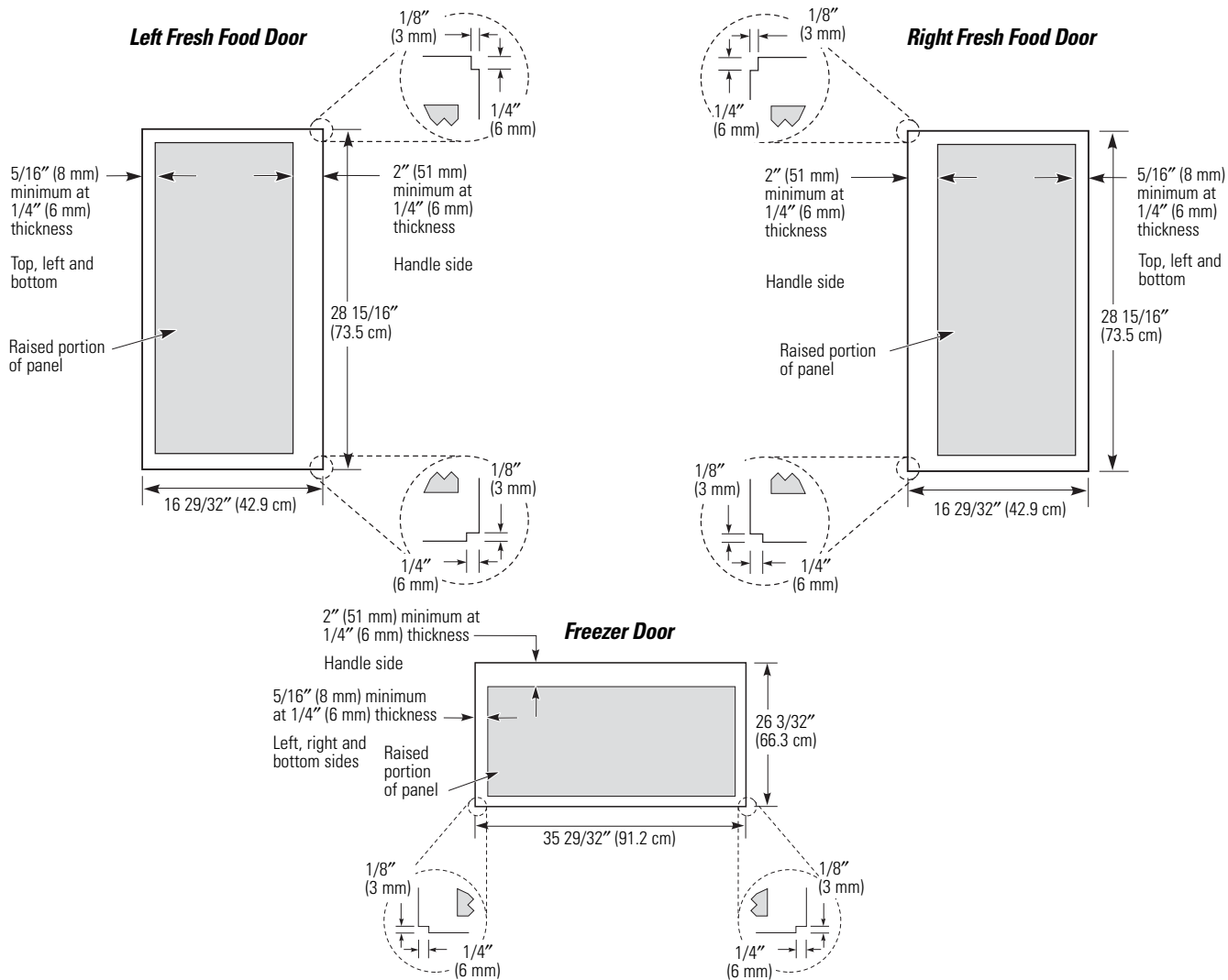

POWER CORD

The power cord of this appliance is equipped with a 3-prong (grounding) plug, which mates with a standard 3-prong (grounding) wall outlet to minimize the possibility of electric shock hazard from this appliance.

Have the wall outlet and circuit checked by a qualified electrician to make sure the outlet is properly grounded.

If the outlet is a standard 2-prong outlet, it is your personal responsibility and obligation to have it replaced with a properly grounded 3-prong wall outlet.

WARNING: Do not, under any circumstances, cut or remove the third (ground) prong from the power cord. For personal safety, this appliance must be properly grounded.

The refrigerator should always be plugged into its own individual electrical outlet, which has a voltage rating that matches the rating plate.

USE OF EXTENSION CORDS

Because of potential safety hazards under certain conditions, we strongly recommend against the use of an extension cord.

However, if you must use an extension cord, it is absolutely necessary that the extension cord be:

- UL-listed (in the United States) or CSA-listed (in Canada).
- A 3-wire grounding type appliance extension cord having a grounding type plug and outlet.
- A cord with an electrical rating of 15 amperes (minimum) and 120 volts.

REFRIGERATOR LOCATION

- Do not install the refrigerator where the temperature will go below 60°F (16°C) because it will not run often enough to maintain proper temperatures.
- Do not install the refrigerator where the temperature will go above 100°F (37°C) because it will not perform properly.
- Install it on a floor strong enough to support it fully loaded.

CLEARANCES

Allow the following clearances for ease of installation, proper air circulation and plumbing and electrical connections.

	Standard Depth Models	Counter Depth Models
Sides	1/8" (3 mm)	1/8" (3 mm)
Top	1" (25 mm)	1" (25 mm)
Back	1" (25 mm)	1/2" (13 mm)

Anti-Tip Floor Bracket (on 21 ft. models)

MATERIALS YOU MAY NEED (not included)



Lag Bolts



Anchor Sleeves

Drill Bit Appropriate for Anchors

For Anti-Tip Bracket Mounted on CONCRETE Floors Only

TOOLS YOU MAY NEED

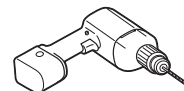

1/8 Drill Bit and Electric or Hand Drill

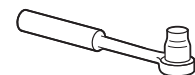

3/8 and 5/16 Socket Ratchet/Driver



Pencil

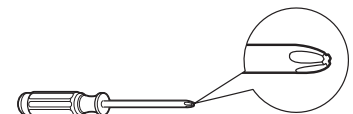

Phillips Head Screwdriver

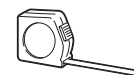

Tape Measure



Level

⚠ WARNING



Under certain circumstances, this refrigerator can tip forward.

Injury to persons can result.

Install Anti-Tip Bracket packed with this refrigerator.

1 MEASURE CABINET OPENING AVAILABLE VS. REFRIGERATOR WIDTH

Measure width of cabinet opening where refrigerator will be placed, *W*.

Be sure to account for any countertop overhang, baseboard thickness and any clearance desired. Width, *W*, should not be less than 36 inches. The refrigerator will be placed approximately in the middle of this opening.

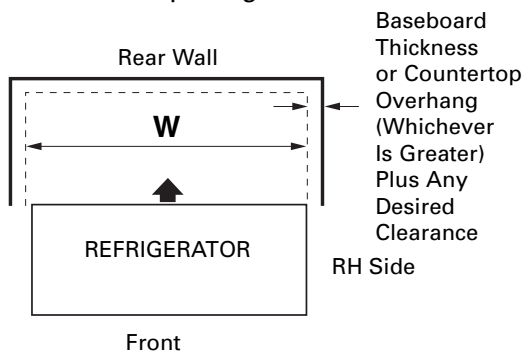

2 LOCATING THE ANTI-TIP FLOOR BRACKET

- A** Place the anti-tip floor bracket locator template (included inside the anti-tip kit) onto the floor up against the rear wall, within *W*, and in line with the desired location of the RH side of the refrigerator (see Figure 1).

Figure 1 – Installation Overview

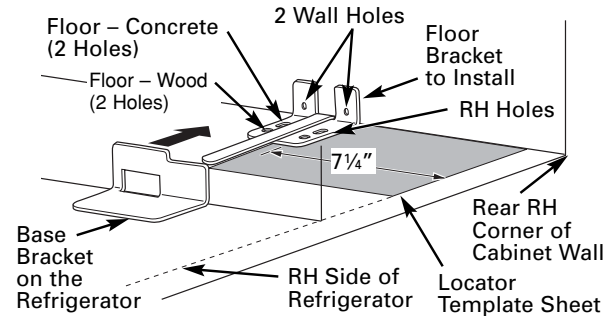

- B** Place the anti-tip floor bracket onto the locator template with its RH floor holes lined up with the floor holes indicated on the template sheet, approximately $7\frac{1}{4}$ " from the edge of the sheet or the RH side of the refrigerator.
- C** Hold down in position and use the anti-tip floor bracket as a template for marking the holes based upon your configuration and type of construction as shown in Step 3. Mark the hole locations with a pencil, nail or awl.

NOTE:

- It is **REQUIRED** to use at least 2 screws to mount the floor bracket (one on each side of the anti-tip floor bracket). Both must be into either the wall or the floor. Figure 2 indicates all the acceptable mounting configurations for screws. Identify the screw holes on the anti-tip floor bracket for your configuration.

2 LOCATING THE ANTI-TIP FLOOR BRACKET (cont.)

Figure 2 – Acceptable Screw Placement Locations

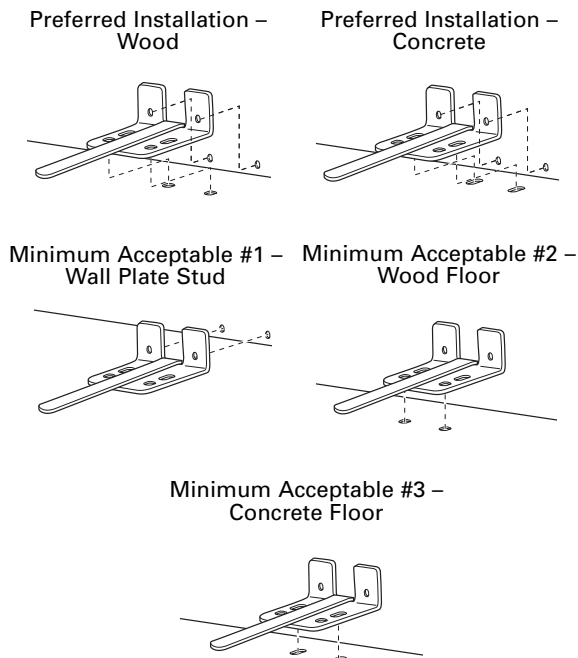

3 ANTI-TIP BRACKET INSTALLATION

A WOOD Wall and Floor Construction:

- Drill the appropriate number of 1/8" pilot holes in the center of each floor bracket hole being used (a nail or awl may be used if a drill is not available) AND remove the locator template from the floor.
- Mount the anti-tip floor bracket by fastening the 2, or preferably 4, #10-16 hex-head screws tightly into place as illustrated in Figure 3.

Figure 3 – Attachment to Wall and Floor

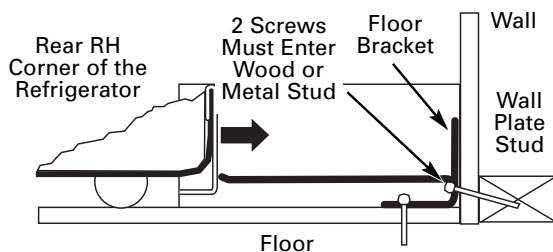

B CONCRETE Wall and Floor Construction:

- Anchors required (not provided):
4 each 1/4" x 1 1/2" lag bolts
4 each 1/2" O.D. sleeve anchors
- Drill the recommended size holes for the anchors into the concrete at the center of the holes marked in Step 2.
- Install the sleeve anchors into the drilled holes. Place the anti-tip floor bracket as indicated in Step 2. Remove the locator template from the floor.
- Install the lag bolts through the anti-tip floor bracket and tighten appropriately.

C WOOD Wall and TILE Floor Construction:

- For this special case, locate the 2 wall holes identified in Fig. 1. Drill an angled 1/8" pilot hole (approx. as shown in Fig. 3) in the center of each hole.
- Mount the anti-tip floor bracket using the Minimum Acceptable Installation #1, as illustrated in Fig. 2.

4 POSITIONING THE REFRIGERATOR TO ENGAGE THE ANTI-TIP FLOOR AND BASE BRACKETS

- ### A
- Before pushing the refrigerator into the opening, plug the power cord into the receptacle and connect waterline (if equipped). Check for leaks.
- ### B
- Locate the refrigerator's RH side and move back approximately in line with the RH side of the cabinet opening, W. This should position the anti-tip floor bracket to engage the anti-tip base bracket on the refrigerator.
- ### C
- Gently roll the refrigerator back into the cabinet opening until it comes to a complete stop. Check to see if the refrigerator front lines up with the cabinet front face. If not, carefully rock the refrigerator forward and backward until engagement occurs and you notice that the refrigerator is fully pushed up against the rear wall.
- ### D
- OPTIONAL: Adjust the rear (and front) wheel height settings to fully engage the rear anti-tip brackets, while also aligning the refrigerator front with the cabinet front face.

NOTE:

If you pull the refrigerator out and away from the wall for any reason, make sure the anti-tip floor bracket is engaged when the refrigerator is pushed back against the rear wall.

1 REMOVE THE FRESH FOOD DOOR HANDLE

(For placement in the installation location or reversal of the handles – on some models)

Stainless steel (on some models):

- A REMOVING THE DOOR HANDLE:** Loosen the set screws with the 3/32" Allen wrench and remove the handle. **NOTE:** For Double Door models follow the same procedure on the opposite door.

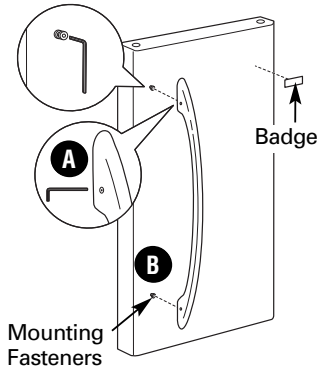

(appearance may vary)

Plastic handle (on some models):

- A REMOVING THE DOOR HANDLE:** Depress the tab on the underside of the handle and slide the handle up and off of the mounting fasteners.

- B REVERSING THE DOOR HANDLE (on some models):**

- Remove the handle mounting fasteners with a 1/4" Allen wrench and transfer the handle mounting fasteners to the right side.

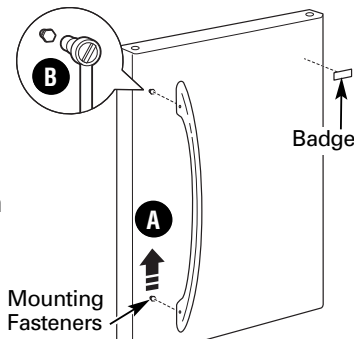

(appearance may vary)

- Remove the logo badge.
- Remove and transfer the plug button to the left side of the fresh food door. **NOTE:** Use a flat plastic edge to prevent damaging the door. Remove any adhesive on the door with a mild detergent. Remove the paper covering on the adhesive backing on the logo badge prior to carefully attaching the badge to the door.

2 ATTACH THE FRESH FOOD DOOR HANDLE

Stainless steel handle:

- A** Attach the handle to the handle mounting fasteners and tighten the set screws with a 3/32" Allen wrench.

NOTE: For Double Door models follow the same procedure on the opposite door.

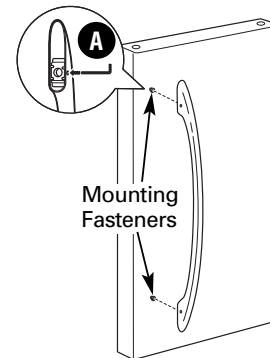

(appearance may vary)

Plastic handle:

- A** Attach the handle to the handle mounting fasteners by aligning the slots with the handle mounting fasteners.
- B** Slide it down until it is firmly locked into position.

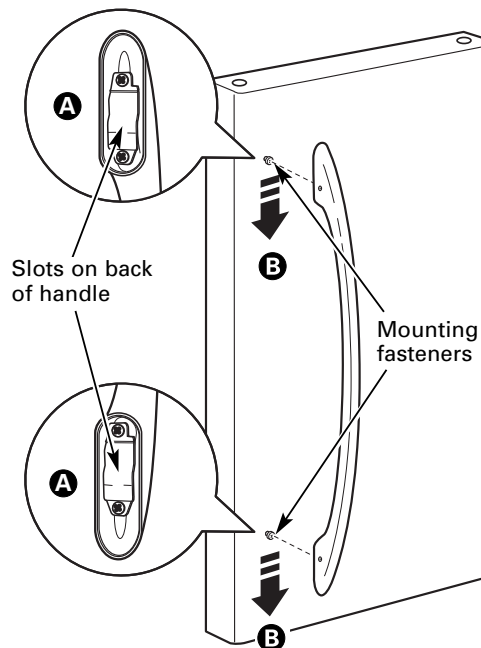

(appearance may vary)

IMPORTANT NOTES

When reversing the door swing:

NOTE: Door swing is not reversible on stainless steel models.

- Read the instructions all the way through before starting.
- Parts are included in the door hinge kit.
- Handle parts carefully to avoid scratching paint.
- Set screws down by their related parts to avoid using them in the wrong places.
- Provide a non-scratching work surface for the doors.

IMPORTANT: Once you begin, do not move the cabinet until door-swing reversal is completed.

These instructions are for changing the hinges from the right side to the left side—if you ever want to change the hinges back to the right side, follow these same instructions and reverse all references to left and right.

- Once door swing is finalized, ensure the logo badge is properly aligned and permanently secured to the door by removing the adhesive cover on the back side.

NOTE: A replacement logo badge is included in the hinge kit.

Unplug the refrigerator from its electrical outlet.

Empty all door shelves, including the dairy compartment.

TOOLS YOU MAY NEED



Adjustable Wrench

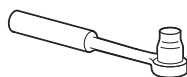

5/16" Socket Ratchet/Driver



Masking Tape



Thin-blade Screwdriver

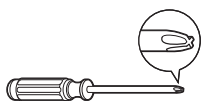

Phillips Screwdriver

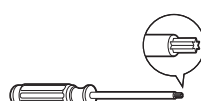

Torx T-20 Driver

1 REMOVE THE REFRIGERATOR DOOR

- A** Tape the door shut with masking tape.

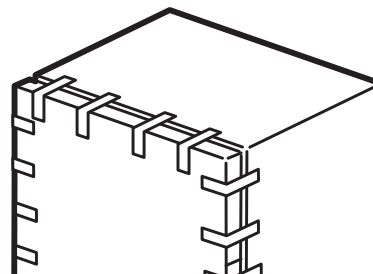

- B** Remove the hinge cover on top of the refrigerator door by removing the Phillips head screws and pulling it up.

- C** Using a 5/16" socket ratchet/driver, remove the bolts securing the top hinge to the cabinet. Then lift the hinge straight up to free the hinge pin from the socket in the top of the door.

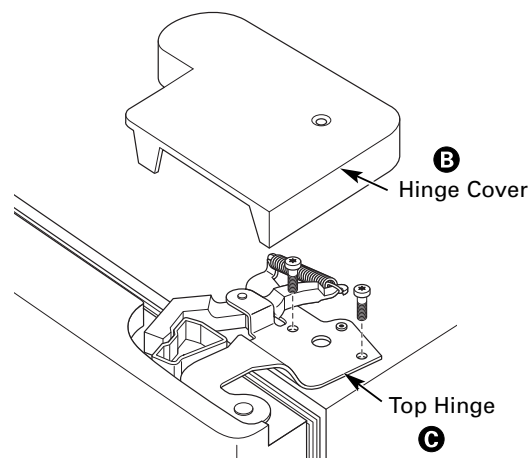

- D** Remove the tape and tilt the door away from the cabinet. Lift the door off the center hinge pin. Ensure that the plastic hinge pin thimble remains on the hinge pin or inside door hinge pin hole located in the bottom of the door.

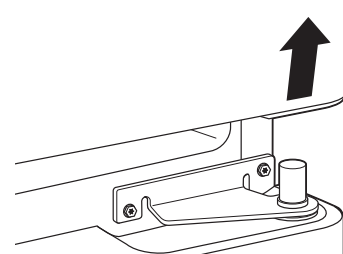

- E** Set the door on a non-scratching surface with the inside up.

2 REMOVE CENTER HINGE

Using a 5/16" socket ratchet/driver, remove the bolts securing the center hinge to the cabinet. Set the hinge and bolts aside.

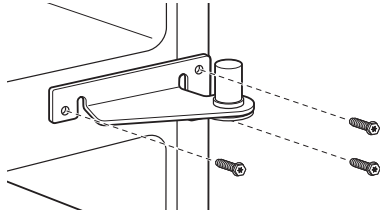

3 INSTALL CENTER HINGE

A Transfer the plug button and screw hole cover in the hinge holes on the left side to the right side.

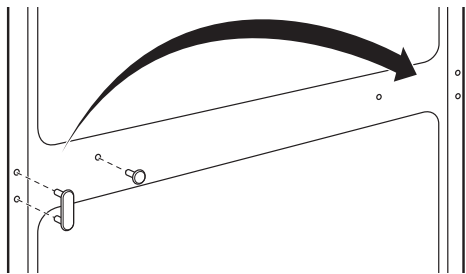

B Install the center hinge from the kit on the left side.

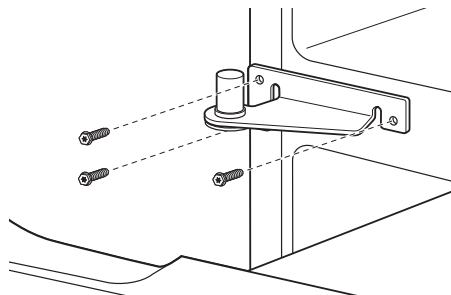

NOTE: A new hinge will be required for the left side (supplied in the door hinge kit).

4 TRANSFER REFRIGERATOR DOOR STOP

- A** Remove the door stop on right side of the bottom of the refrigerator door by removing the two screws.
- B** Move the plastic hinge hole thimble to the opposite hole.
- C** Install the door stop on the left side, making sure to line up the screw holes in the door stop with the holes in the bottom of the door.

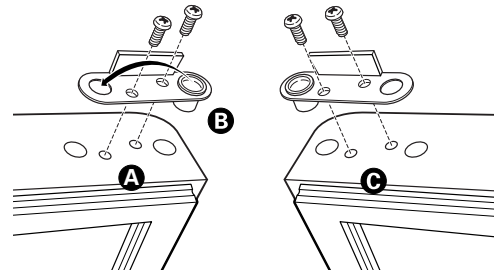

Bottom of Refrigerator Door (Right Side)

Bottom of Refrigerator Door (Left Side)

5 TRANSFER REFRIGERATOR DOOR HANDLE TO RIGHT

Refer to Remove the Fresh Food Door Handle and Attach the Fresh Food Door Handle sections for instructions.

6 REHANG REFRIGERATOR DOOR

- A** Lower the refrigerator door onto the center hinge pin. Ensure that the plastic hinge pin thimble is on the center hinge pin or inside door hinge pin hole located in the bottom of the door.

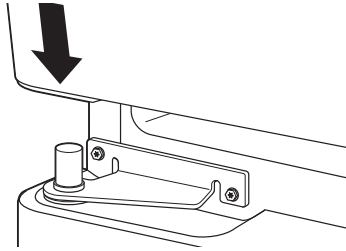

- B** Insert the top hinge pin into the hinge hole on top of the refrigerator door. Make sure the door is aligned with the cabinet. Attach the hinge to the top of the cabinet loosely with the bolts.

- C** Make sure the gasket on the door is flush against the cabinet and is not folded. Support the door on the handle side and make sure the door is straight and the gap between the doors is even across the front. While holding the door in place, tighten the top hinge bolts. Replace the hinge cover.

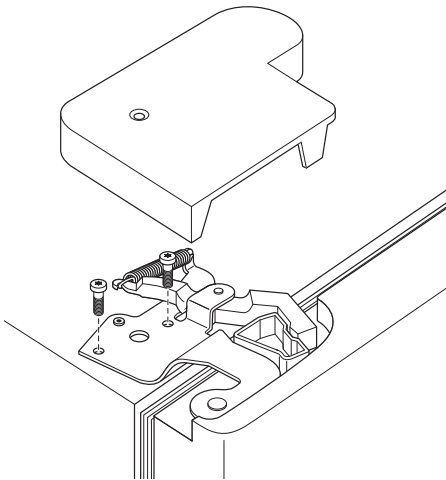

7 INSTALL THE LOGO BADGE

Remove the adhesive backing paper and align the pins on the back of the badge with the holes in the door. Apply pressure to the badge to ensure it sticks to the door.

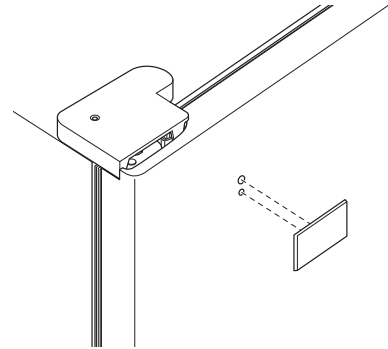

Freezer Drawer Handle

1 REMOVE THE FREEZER DOOR HANDLE

Stainless steel and plastic handles:

- A** Loosen the set screws located on the underside of the handle with the 1/8" Allen wrench and remove the handle.

NOTE: If the handle mounting fasteners need to be tightened or removed use a 1/4" Allen wrench.

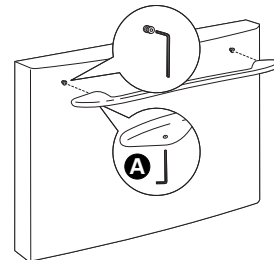

2 ATTACH THE FREEZER DOOR HANDLE

Stainless steel and plastic handles:

- A** Attach the handle firmly to the mounting fasteners and tighten the set screws on the bottom of the handle with a 1/8" Allen wrench.

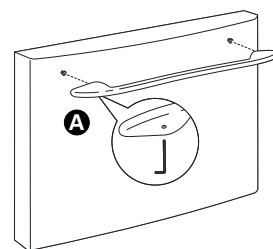

(appearance may vary)

IMPORTANT NOTES

NOTE: Door swing is not reversible.

- Read the instructions all the way through before starting.
- Handle parts carefully to avoid scratching paint.
- Set screws down by their related parts to avoid using them in the wrong places.
- Provide a non-scratching work surface for the doors.

IMPORTANT: Once you begin, do not move the cabinet.

These instructions are for removing the doors.

Unplug the refrigerator from its electrical outlet.

Empty all door shelves, including the dairy compartment.

TOOLS YOU MAY NEED



Adjustable Wrench

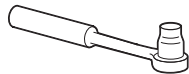

3/8" and 10 mm Socket Ratchet/Driver



Masking Tape



Thin-blade Screwdriver

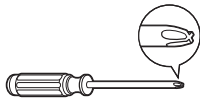

Phillips Screwdriver

1 REMOVE THE REFRIGERATOR DOORS

A Tape the doors shut with masking tape.

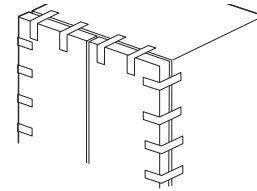

(for water dispenser models)

B Start with right-hand door first: Remove the screw securing the center hinge cover, lift the hinge cover and place to the side on top of the refrigerator.

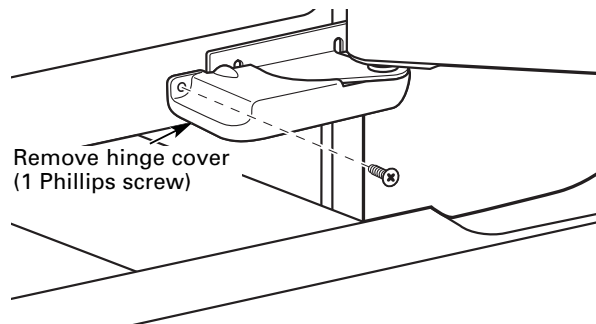

Remove hinge cover (1 Phillips screw)

(for water dispenser models)

C Remove water coupling and power coupling.

C1

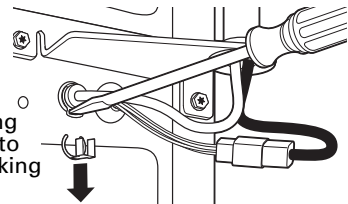

Water Coupling

Remove the metal spring clip. Use a screwdriver to push the red plastic locking clip down and off.

C2

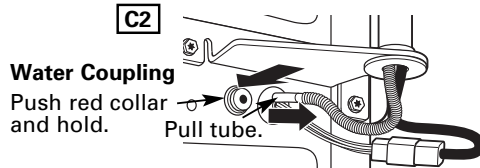

Water Coupling

Push red collar and hold. Pull tube.

C3

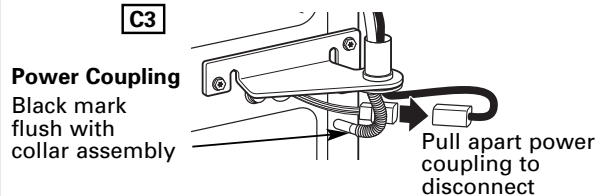

Power Coupling

Black mark flush with collar assembly

Pull apart power coupling to disconnect

1 REMOVE THE REFRIGERATOR DOORS (cont.)

- D** Remove the hinge cover on top of the refrigerator door by removing the Phillips head screws and pulling it up.
- E** Using a 5/16" socket ratchet/driver, remove the bolts securing the top hinge to the cabinet. Then lift the hinge straight up to free the hinge pin from the socket in the top of the door.

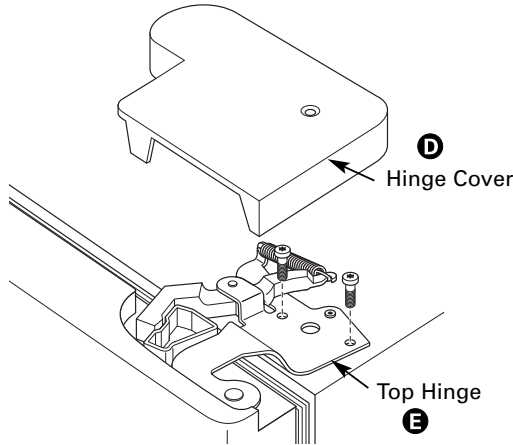

- F** Remove the tape and tilt the door away from the cabinet. Lift the door off the center hinge pin. Ensure that the plastic hinge pin thimble remains on the hinge pin or inside door hinge pin hole located in the bottom of the door.

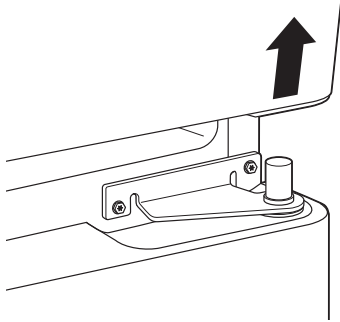

- G** Set the door on a non-scratching surface with the inside up.

2 REMOVE OPPOSITE DOOR

Follow the same procedure on the opposite door. There are no wires, water lines or center hinge covers on the opposite side.

3 REMOVE FREEZER DRAWER

Refer to the Removing the Freezer Drawer section for instructions.

4 REHANG REFRIGERATOR DOORS

- A** Lower the refrigerator door onto the center hinge pin. Ensure that the plastic hinge pin thimble is on the center hinge pin or inside door hinge pin hole located in the bottom of the door.

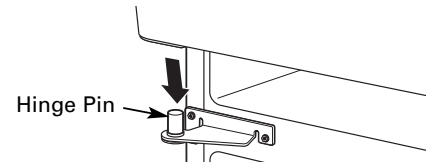

- B** Securely tape the door shut with masking tape or have a second person support the door.
- C** Route wires through bottom right hinge pin slot. Insert the top hinge pin into the hinge hole on top of the refrigerator door. Make sure the door is aligned with the cabinet and opposite door. Attach the hinge to the top of the cabinet loosely with the bolts.

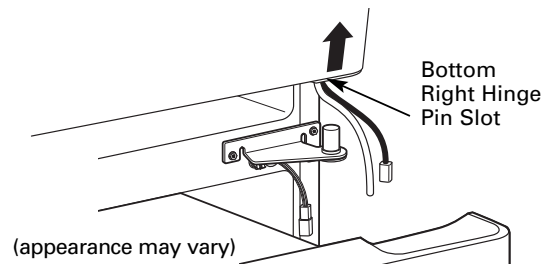

- D** On right-hand doors, pass the wires and water line through the center hinge pin. Then connect the water line and 4-pin connector.

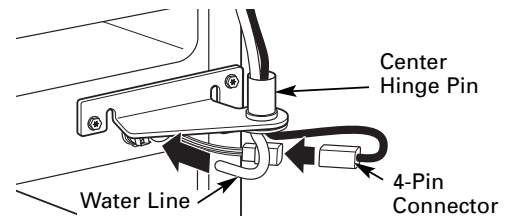

5 REHANG REFRIGERATOR DOORS (CONT.)

- E** Make sure the gasket on the door is flush against the cabinet and is not folded. Make sure the door is straight and the gap between the doors is even across the front. While holding the aligned door in place, tighten the top hinge bolts. Replace the hinge cover and screw.

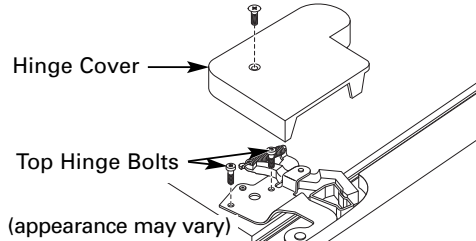

6 REPLACE OPPOSITE DOOR

Follow the same procedure on the opposite door. There is no water line or hinge cover.

7 ALIGN DOUBLE DOORS

If the top of the doors are uneven, first try to raise the lowest door by turning the leveling leg on the same side as the door until the doors are even. If the unit rocks, re-adjust the leveling legs to the extent that the unit is stable.

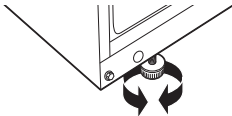

If the doors remain uneven, turn the adjustable pin to raise, or lower, the left door to match the right door. Use a 1/4" Allen wrench to turn the pin.

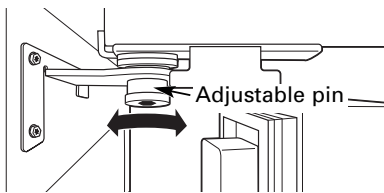

8 REPLACE FREEZER DRAWER

Refer to the Replacing the Freezer Drawer section for instructions.

Removing and Installing the Freezer Drawer (Some Models)

1 REMOVE THE BASKET

- A** Open the freezer drawer until it stops.
B Cut the 2 wire ties off of the basket with wire cutters.
C The freezer basket rests inside 4 tabs on the freezer slides. Lift the basket up and out of the 4 tabs.
D Tilt the front up and lift the entire basket up and out of the drawer.

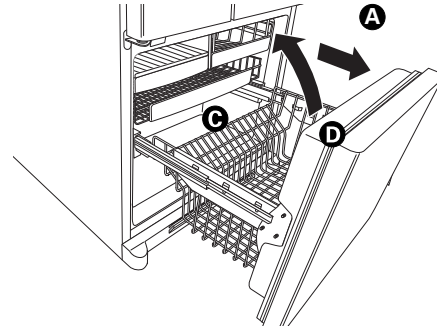

2 REMOVE THE DRAWER FRONT FROM THE SLIDES

- A** Remove the 10 hex head screws from the door and remove the door.
DO NOT remove the torx screws from the rail assemblies.

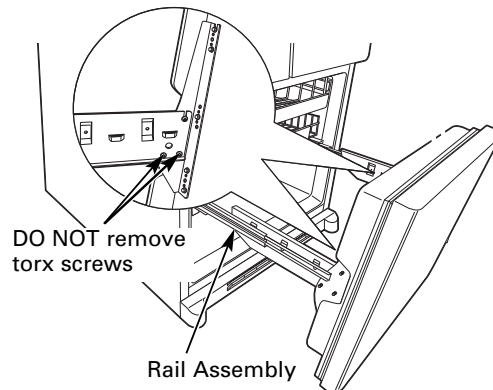

- B** Set the drawer front on a non-scratching surface.
C Push the rail assemblies back into the cabinet.

(Continued next page)

3 ATTACH AND SECURE THE DRAWER FRONT TO THE SLIDES

A Pull out the rail assemblies to the full length on each side of the cabinet.

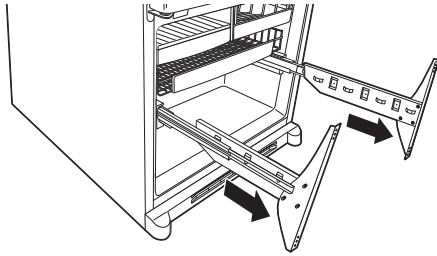

B Drive the top screw into the door on each side until it is 1/2 way in.

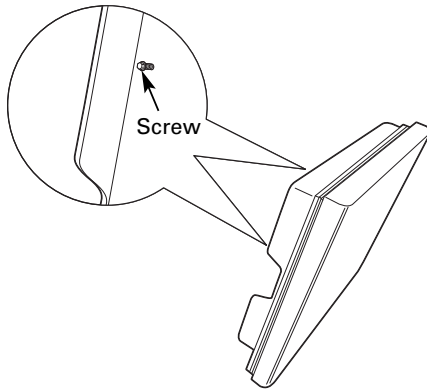

C Hang the drawer front onto open slots on the slides.

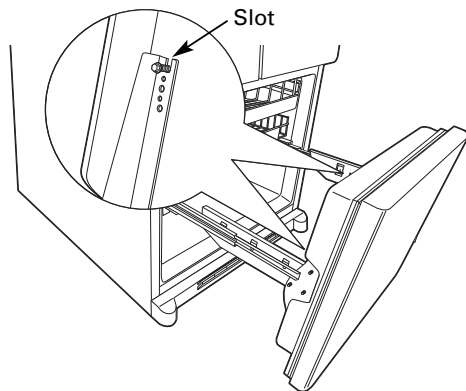

4 ATTACH AND SECURE THE DRAWER FRONT TO THE SLIDES (CONT.)

D Drive screws fully. (There are 10 screws.)

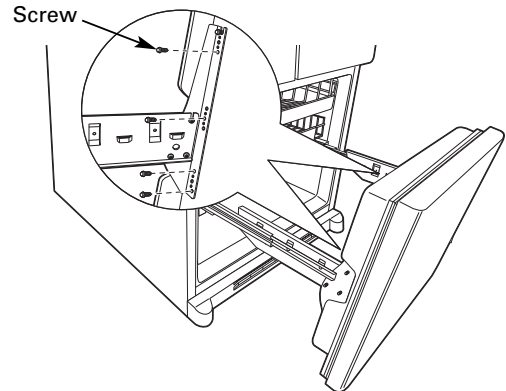

Step D2:
Drive fully.

Step D3:
Drive screws in these holes.

Step D1:
Line up screw hole in freezer drawer and drive fully.



5 REPLACE THE FREEZER BASKET

Replace the lower freezer basket by lowering it into the frame.

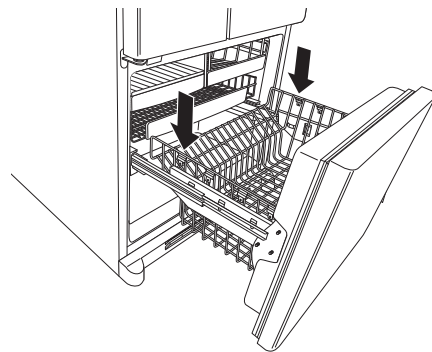

Control Features

About the controls with temperature settings.

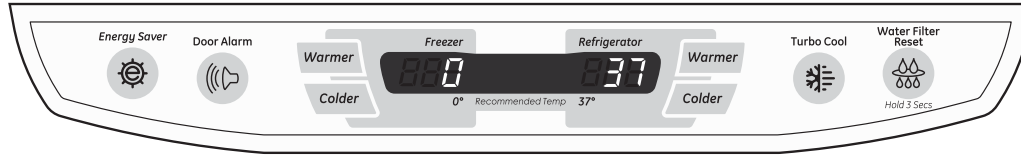

(on some models)

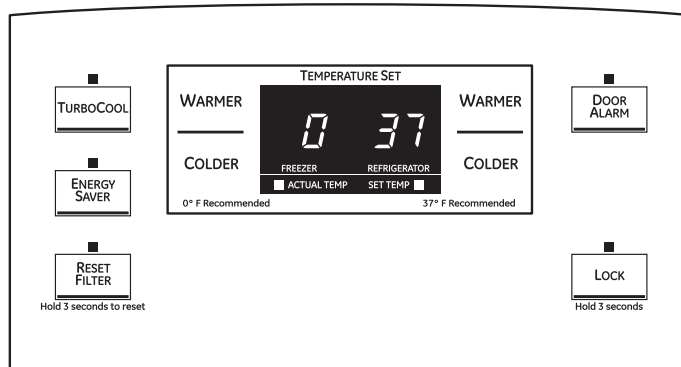

(on some models)

NOTE: The refrigerator is shipped with protective film covering the temperature controls. If this film was not removed during installation, remove it now.

The temperature controls are preset in the factory at **37°F** for the refrigerator compartment and **0°F** for the freezer compartment. Allow 24 hours for the temperature to stabilize to the preset recommended settings.

The temperature controls can display both the **SET** temperature as well as the actual temperature in the refrigerator and freezer. The actual temperature may vary slightly from the **SET** temperature based on usage and operating environment.

Setting either or both controls to **OFF** stops cooling in both the freezer and refrigerator compartments, but does not shut off electrical power to the refrigerator.

Changing the Temperature

For Controls-on-the-Door Models:

To change the temperature, press and release the **WARMER** or **COLDER** pad. The **ACTUAL TEMP** light will come on and the display will show the actual temperature. To change the temperature, tap either the **WARMER** or **COLDER** pad until the desired temperature is displayed.

For Controls Inside the Refrigerator:

Opening the door displays the actual temperature. To change the temperature, press either the **WARMER** or **COLDER** touch pads until the desired temperature is displayed.

Once the desired temperature has been set, the temperature display will return to the actual refrigerator and freezer temperatures after 5 seconds. Several adjustments may be required.

Each time you adjust controls, allow 24 hours for the refrigerator to reach the temperature you have set.

To turn the cooling system off, tap the **WARMER** pad for either the refrigerator or the freezer until the display shows **OFF**. **To turn the unit back on**, press the **COLDER** pad for either the refrigerator or freezer. Then press the **COLDER** pad again and it will go to the preset points of **0°F** for the freezer and **37°F** for the refrigerator. Setting either or both controls to **OFF** stops cooling in both the freezer and refrigerator compartments, but does not shut off electrical power to the refrigerator.

About TurboCool.™ (on some models)

Turbo Cool



(on some models)

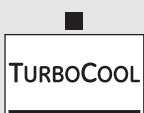

(on some models)

How it Works

TurboCool rapidly cools the refrigerator compartment in order to more quickly cool foods. Use **TurboCool** when adding a large amount of food to the refrigerator compartment, putting away foods after they have been sitting out at room temperature or when putting away warm leftovers. It can also be used if the refrigerator has been without power for an extended period.

Once activated, the compressor will turn on immediately and the fans will cycle on and off at high speed as needed for eight hours. The compressor will continue to run until the refrigerator compartment cools to approximately 34°F (1°C), then it will cycle on and off to maintain this setting. After 8 hours, or if **TurboCool** is pressed again, the refrigerator compartment will return to the original setting.

How to Use

Press **TurboCool**. The refrigerator temperature display will show **EC**.

After **TurboCool** is complete, the refrigerator compartment will return to the original setting.

NOTES: The refrigerator temperature cannot be changed during **TurboCool**.

The freezer temperature is not affected during **TurboCool**.

When opening the refrigerator door during **TurboCool**, the fans will continue to run if they have cycled on.

Door Alarm



(on some models)



(on some models)

About Door Alarm (on some models)

The door alarm will sound if any door is open for more than 2 minutes. The beeping stops when you close the door.

Energy Saver



(on some models)



(on some models)

About Energy Saver (on some models)

This product is equipped with an Energy Saver feature. The refrigerator is shipped with the Energy Saver feature enabled.

Over time, moisture can form on the front surface of the refrigerator cabinet and cause rust. If moisture does appear on the front surface of the refrigerator cabinet, turn off the Energy Saver feature by pressing and releasing the **ENERGY SAVER** pad on the control panel.

About the water filter. (on some models)

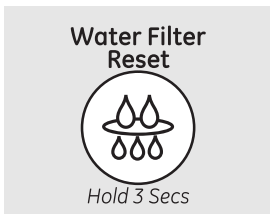
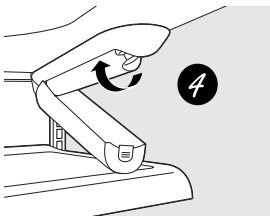
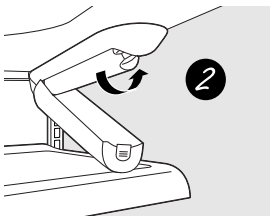
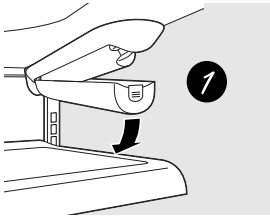
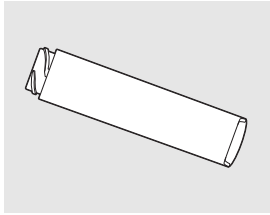

(on some models)

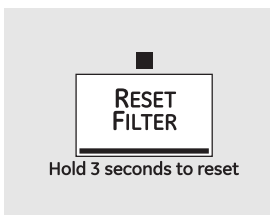

(on some models)

Water Filter Cartridge

The water filter cartridge is located in the back upper right corner of the refrigerator compartment.

When to Replace the Filter

There is a replacement indicator light for the water filter cartridge on the temperature display. This light will turn orange to tell you that you need to replace the filter soon. The filter cartridge should be replaced when the replacement indicator light turns red or if the flow of water to the dispenser or icemaker decreases.

Installing the Filter Cartridge

- 1 If you are replacing the cartridge, first remove the old one. Open the cartridge cover by pressing in on the tab at the front and pulling down.
- 2 Remove the cartridge by slowly rotating it counterclockwise. A small amount of water may drip down.

⚠ CAUTION: If air has been trapped in the system, the filter cartridge may be ejected as it is removed. Use caution when removing.

- 3 Remove the protective foil from the end of the cartridge.
- 4 Lining up the arrow on the cartridge and the cartridge holder, slowly rotate the cartridge clockwise until it stops. When the cartridge is properly installed, you will feel it “click” as it locks into place. The grip on the end of the cartridge should be positioned vertically. **Do not overtighten.**
- 5 Close the cartridge cover.
- 6 Run water from the dispenser for 3 minutes (about 1½ gallons) to clear the system and prevent sputtering. See *To Use the Dispenser* section.
- 7 Press and hold the **RESET WATER FILTER** pad for 3 seconds.

NOTE: A newly-installed water filter cartridge may **cause water to spurt** from the dispenser.

Filter Bypass Plug

You must use the filter bypass plug when a replacement filter cartridge is not available. The icemaker will not operate without the filter or filter bypass plug.

Replacement Filters:

To order additional filter cartridges in the United States, visit our Website, ge.com, or call GE Parts and Accessories, 800.626.2002.

Filter Model GSWF

Customers in Canada should consult the yellow pages for the nearest Mabe Service Center.

About the automatic icemaker.

A newly installed refrigerator may take 12 to 24 hours to begin making ice.

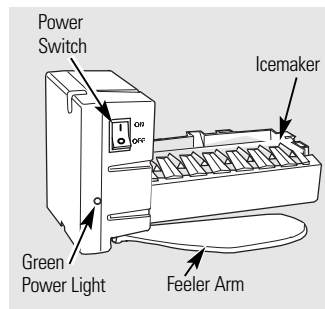

Automatic Icemaker (on some models)

The icemaker will produce seven cubes per cycle—approximately 100–130 cubes in a 24-hour period, depending on freezer compartment temperature, room temperature, number of door openings and other use conditions.

See below for how to access ice and reach the power switch.

If the refrigerator is operated before the water connection is made to the icemaker, set the power switch in the **O (off)** position.

When the refrigerator has been connected to the water supply, set the power switch to the **I (on)** position. The icemaker power light will turn green when the freezer light switch is pressed in or when the freezer door is closed.

The icemaker will fill with water when it cools to 15°F (–10°C). A newly installed refrigerator may take 12 to 24 hours to begin making ice cubes.

You will hear a buzzing sound each time the icemaker fills with water.

Throw away the first few batches of ice to allow the water line to clear.

Be sure nothing interferes with the sweep of the feeler arm.

When the bin fills to the level of the feeler arm, the icemaker will stop producing ice. It is normal for several cubes to be joined together.

If ice is not used frequently, old ice cubes will become cloudy, taste stale and shrink.

NOTE: In homes with lower-than-average water pressure, you may hear the icemaker cycle multiple times when making one batch of ice.

NOTE: Set the power switch to the **O (off)** position if the water supply is shut off.

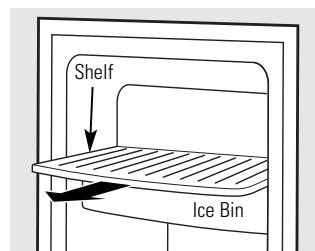

To reach the power switch.

Accessing Ice and Reaching the Power Switch

To reach the icemaker power switch, pull the shelf above the ice bin straight out. Always be sure to replace the shelf.

To access ice, simply pull the bin forward.

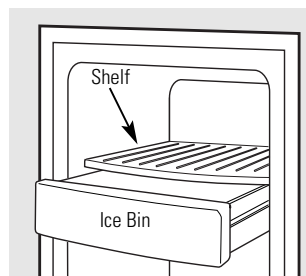

To access ice.

Icemaker Accessory Kit

If your refrigerator did not come already equipped with an automatic icemaker, an icemaker accessory kit is available at extra cost.

Check the back of the refrigerator for the specific icemaker kit needed for your model.

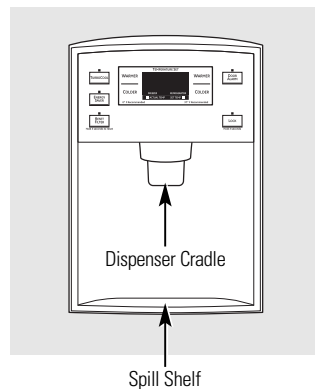

To Use the Dispenser

Press the glass gently against the top of the dispenser cradle.

The spill shelf is not self-draining. To reduce water spotting, the shelf should be cleaned regularly.

If no water is dispensed when the refrigerator is first installed, there may be air in the water line system. Press the dispenser arm for at least two minutes to remove trapped air from the water line and to fill the water system. To flush out impurities in the water line, throw away the first six glassfuls of water.

Locking the Dispenser

Press the **LOCK** pad for 3 seconds to lock the dispenser and control panel. To unlock, press and hold the pad again for 3 seconds.

Door Alarm

To set the alarm, press the **DOOR ALARM** pad. The indicator light will illuminate. This alarm will sound if either door is open for more than 2 minutes. The beeping stops when you close the door.

Replacing the light bulbs.

Turning the control to the **0 (off)** position does not remove power to the light circuit.

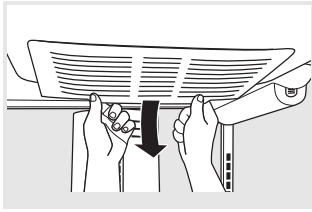

Refrigerator Lights

⚠ CAUTION: Light bulbs may be hot.

- 1 Unplug the refrigerator.
- 2 To remove the light shield, grasp the shield at the back and pull out to release the tabs at the back.
- 3 Rotate the shield down and then forward to release the tabs at the front of the shield.

4 After replacing with an appliance bulb of the same or lower wattage, replace the shield.

5 Plug the refrigerator back in.

NOTE: Appliance bulbs may be ordered from GE Parts and Accessories, 800.626.2002.

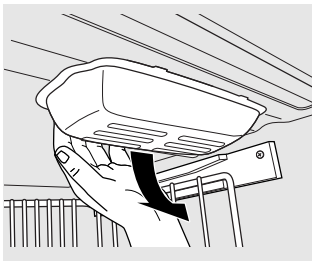

Appearance may vary

Freezer Light

⚠ CAUTION: Light bulbs may be hot.

- 1 Unplug the refrigerator.
- 2 The bulb is located at the top of the freezer inside a light shield. To remove the shield, grasp the shield at the back and pull out to release the tabs at the back.
- 3 Rotate the shield down and then forward to release the tabs at the front of the shield.

4 After replacing with an appliance bulb of the same or lower wattage, replace the shield.

5 Plug the refrigerator back in.

Defrost Cycle

The refrigerator utilizes an adaptive defrost cycle that operates a glass enclosed heater to remove frost from the evaporator. Defrost time has changed from 60 hours adaptive defrost to 96 hours adaptive defrost.

The control board determines the length of time the heater is energized. It does this by monitoring the freezer evaporator thermistor. Once the temperature of the thermistor reaches 75°F, the control cycles the defrost heater off. A bi-metal safety thermostat provides a backup in the event the evaporator thermistor fails. The safety thermostat prevents the temperature from exceeding 140°F.

Note: Refer to Pub# 31-9062 for information about basic adaptive defrost.

Liner Protection Mode

The refrigerator incorporates a liner protection mode for the freezer section. The freezer evaporator fan will start and run on high speed if the door has been open for 3 minutes. Air will circulate into the fresh food section if the damper is in the open position.

This mode is controlled by 2 timers. Timer #1 monitors door-open time. A 3-minute door-open count begins when the door is opened. If 3 minutes elapse before the door is closed, the liner protection mode will become active. Once the door is closed, timer #1 resets and liner protection mode goes into standby. In standby, normal fan operation resumes and timer #2 begins a 3-minute door-closed count. If 3 minutes elapse without a door opening, liner protection mode will completely deactivate. If a door is opened within the timer #2 door-closed count, the remaining time in the door-closed count will be deducted from the timer #1 door-open count.

Dispenser Lock

When the dispenser system is locked, actual and set temperatures can be viewed but no dispenser command will be accepted. This includes the dispenser cradle and will prevent accidental dispensing that may be caused by children or pets. If a pad or the cradle is depressed with the system locked, it will be acknowledged with three pulses of the LOCK LED accompanied by an audible tone.

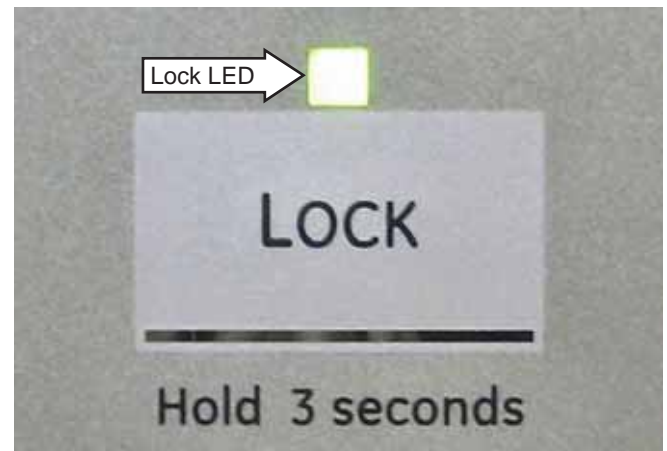

Components Locator Views

Fresh Food Compartment

Single Door Model



French Door Model

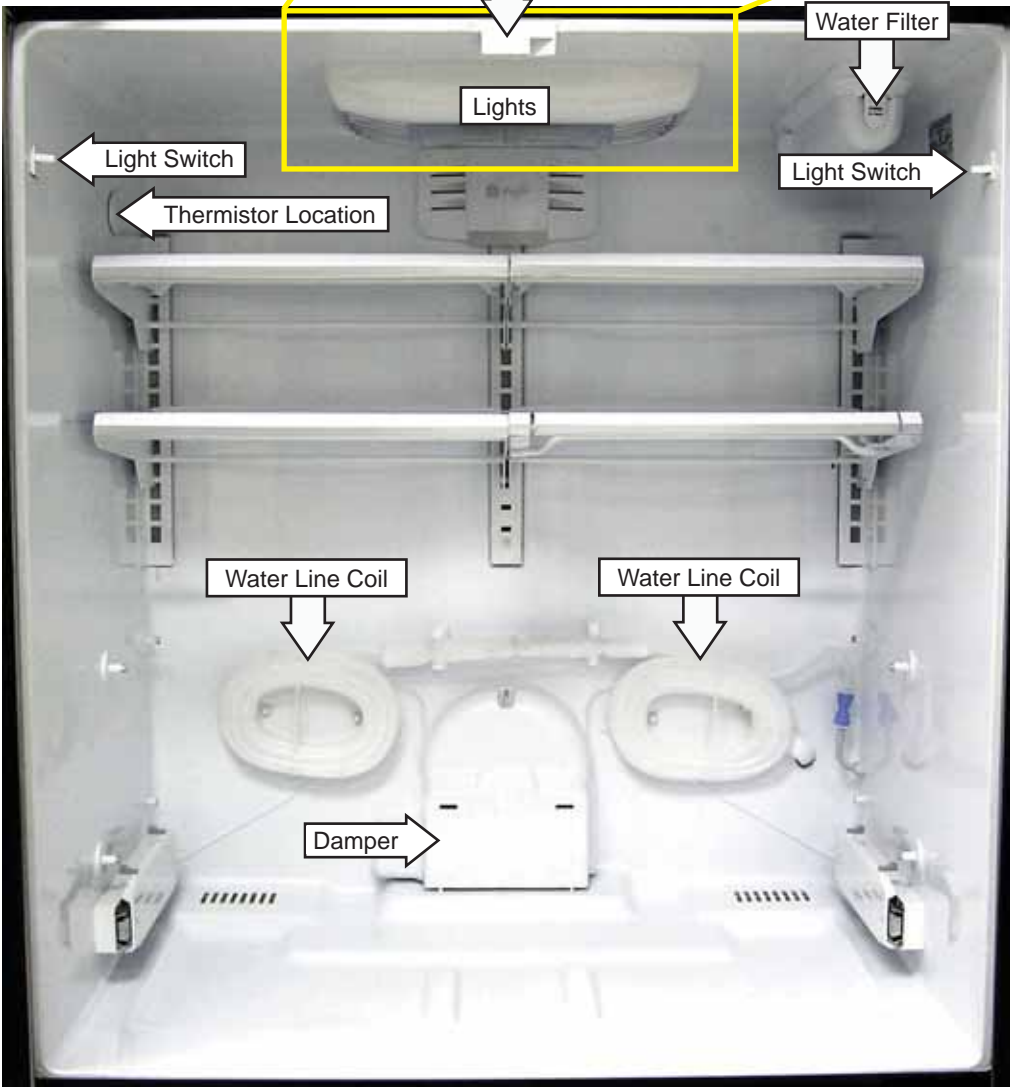

Note: Single door models eliminate the articulating mullion track. On non-dispenser models, the control panel is located in front of the light housing at the top of fresh food compartment.

Freezer Compartment

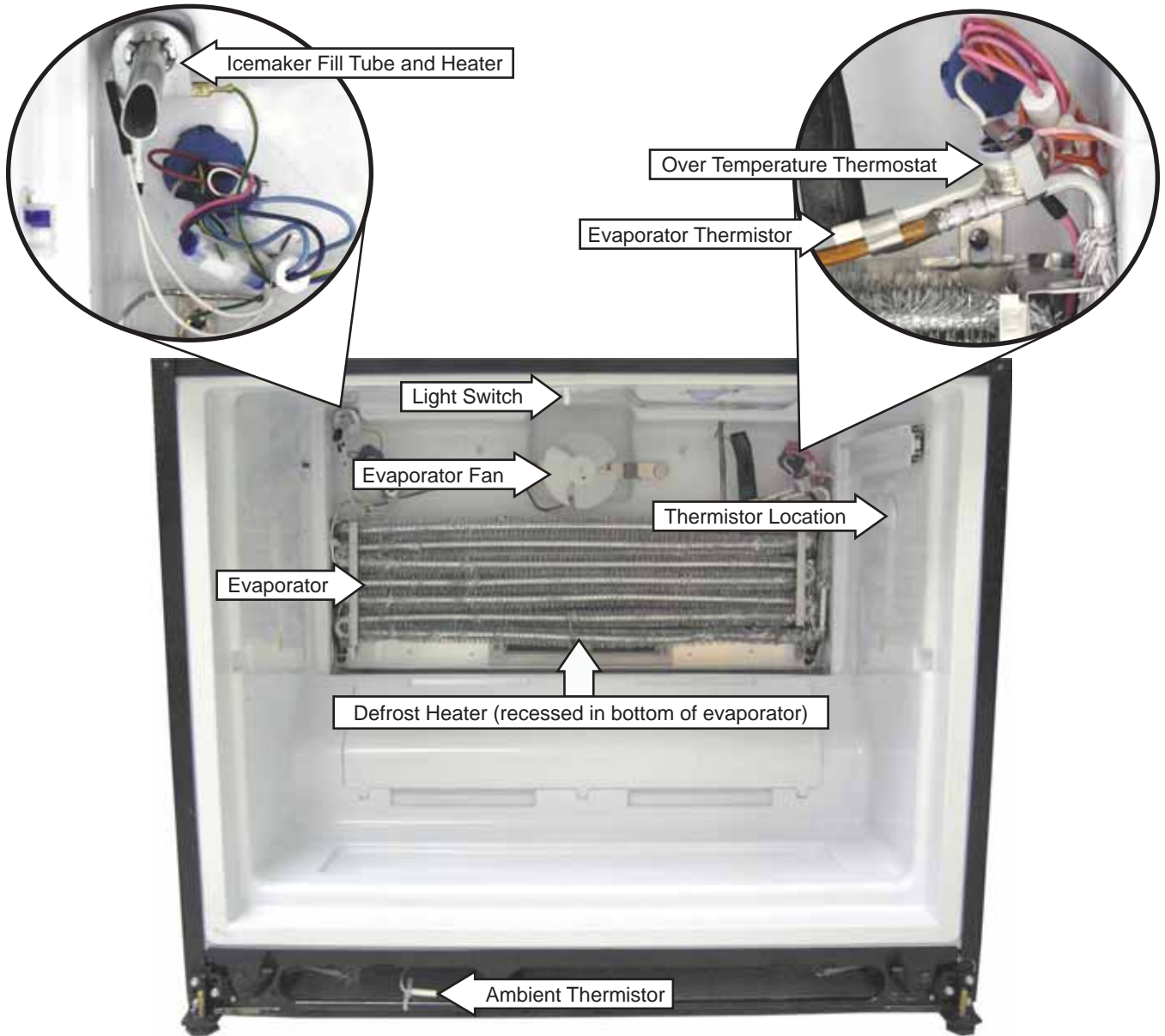

Rear View

Note: The EMI filter is not utilized on 20/22' single and French door models.

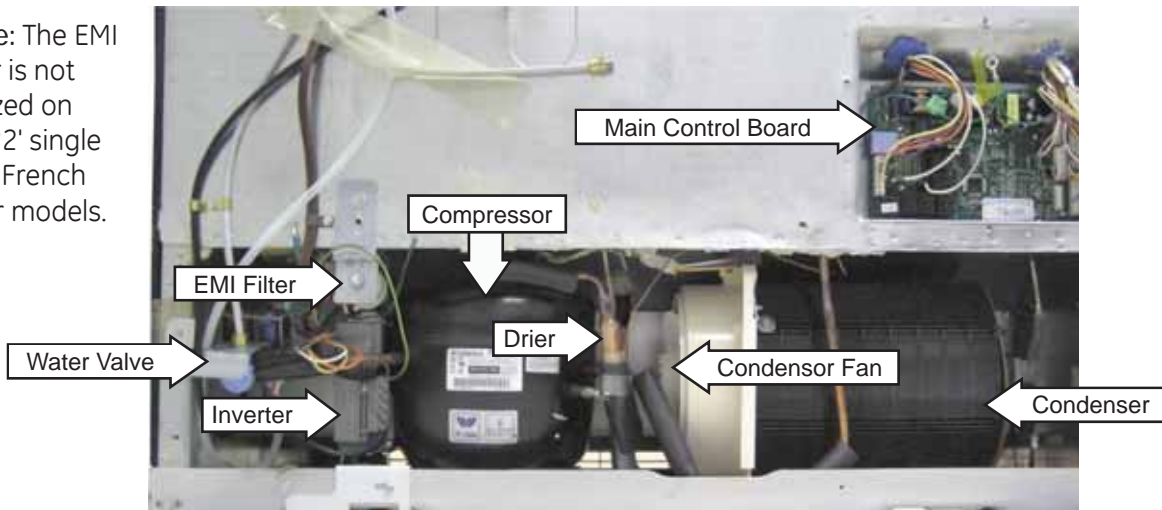

Control Board Connector Locator

Main Control Board

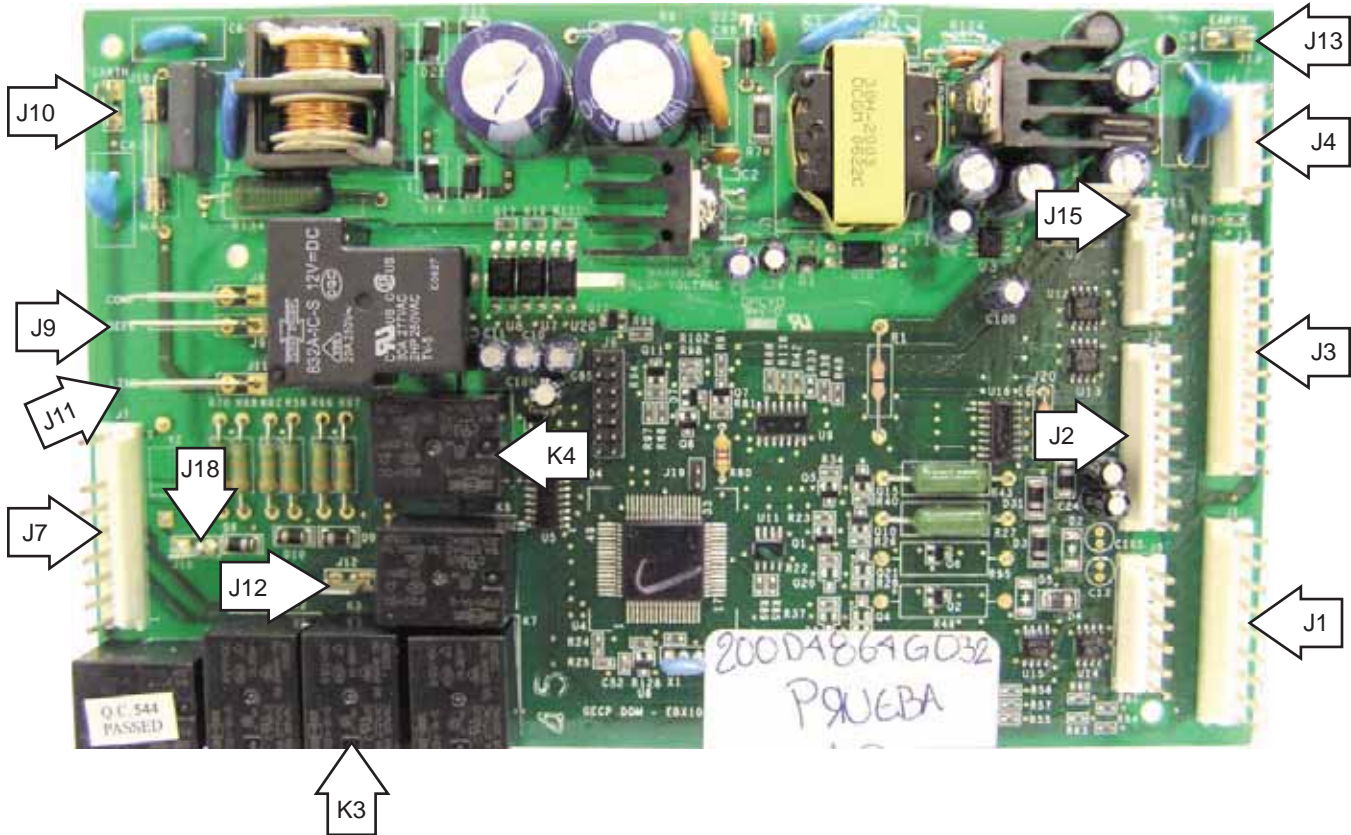

J10 and J13 - Earth (Ground)

J9 - Defrost Heater, Fill Tube Heater, Return Duct Heaters

J11 - Line (L1)

J7 - FF and FZ Interior Lighting Circuits, Dispenser Water Valve (French Door Models Only)

J12 - Mullion Heater

J18 - Icemaker Water Valve (Icemaker Ready Models Only)

K3 - Water

K4 - Defrost

J4 - Display Board

J3 - Damper

J1 - Fresh Food Thermistor, Ambient Thermistor, Freezer Thermistor, Evaporator Thermistor, Model Selector

J15 - Inverter

J2 - Fan Common, Evaporator Fan, Condenser Fan, Mullion Bar Heater, Model Selector

Some of the low voltage DC connector labeling on this model may differ from other models. The function and diagnostics for these connectors are identical for all models.

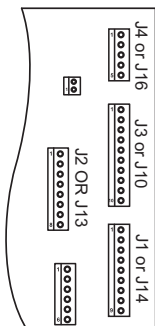

(Continued next page)

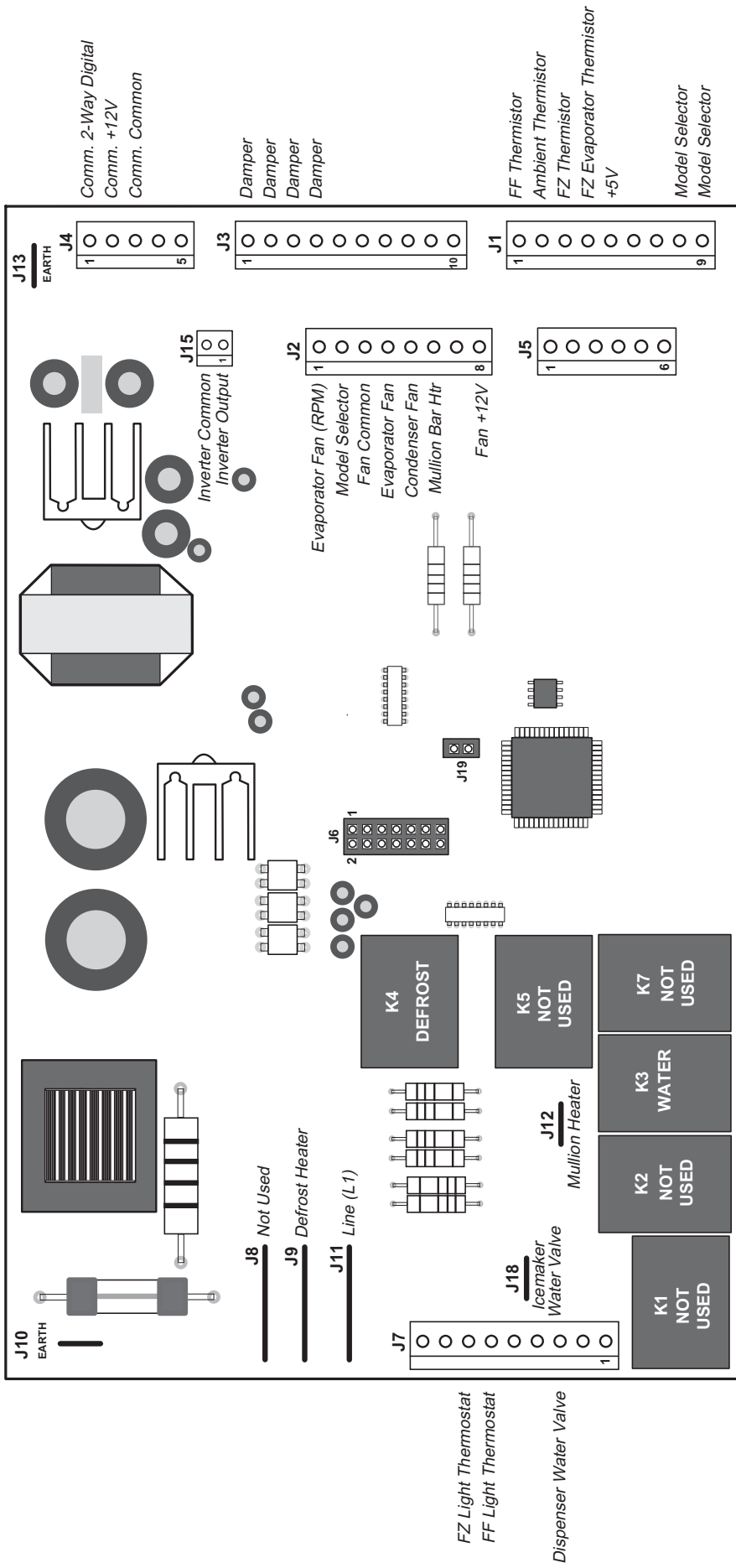

FZ Light Thermostat
FF Light Thermostat

Dispenser Water Valve

Refrigeration System

Refrigeration Components

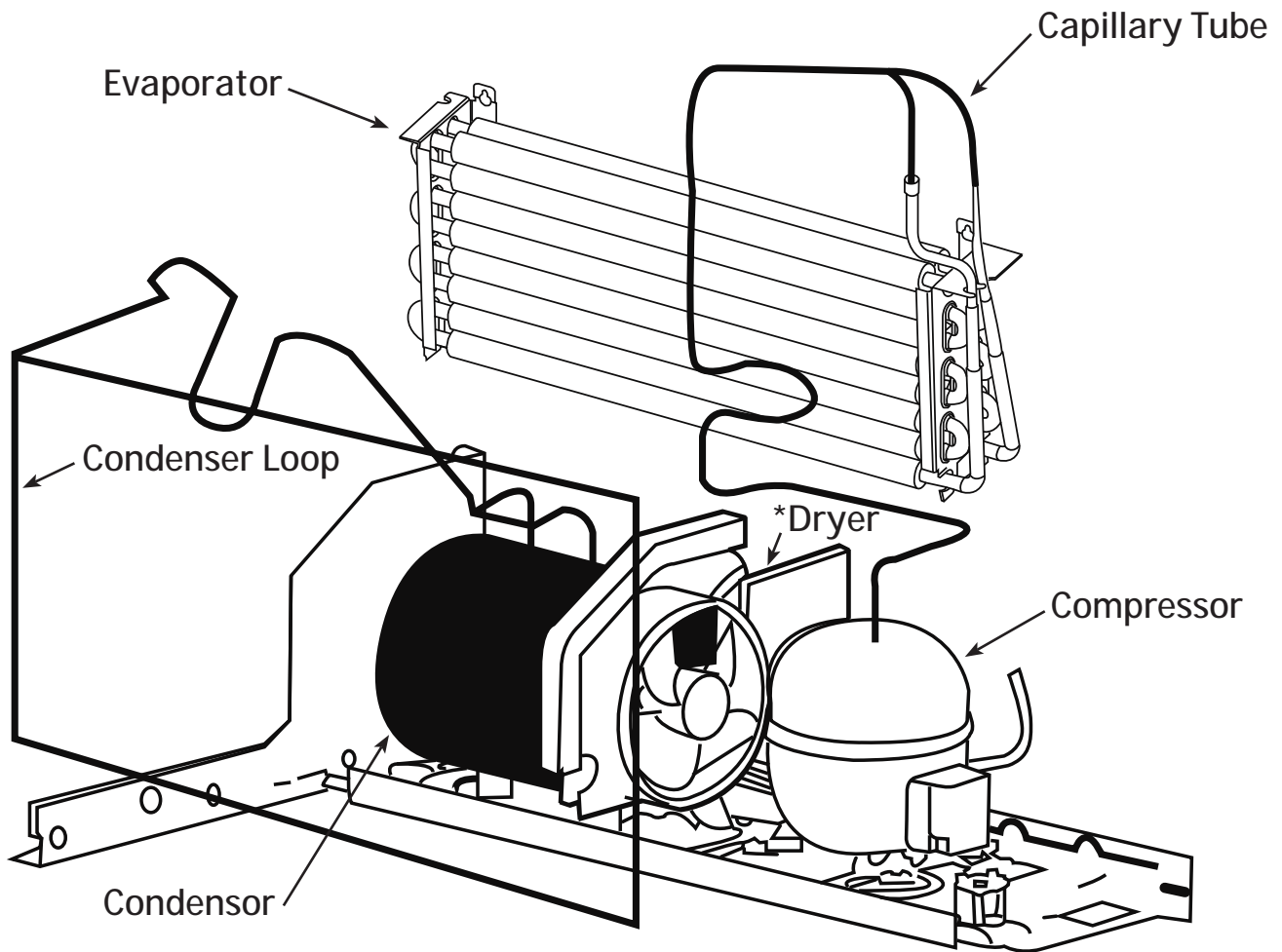

* The dryer (not shown), is vertically positioned between the compressor and the condenser fan motor.

Evacuation and Charging Procedure

WARNING:

- Before cutting or using a torch on refrigerant tubes, recover the refrigerant from the system using approved recovery equipment.
 - Never charge new refrigerant through the purge valve. This valve is always located on the high pressure side of the system.
 - Never apply heat from any source to a container of refrigerant. Such action will cause excessive pressure in the container.
 - Always wear goggles when working with refrigerants and nitrogen holding charge in some replacement parts. Contact with these gases may cause injury.
1. Attach the hose from the R-134a charging cylinder to the process tube port on the compressor.
 2. Evacuate the system to a minimum 20-in. vacuum using the refrigerator compressor and recovery pump, which is attached to the new drier assembly.
 3. Turn off the recovery pump. Close the ball valve on the hose connected to the high-side port connection. Add 3 ounces of R-134a refrigerant to the system. Let the refrigerator operate and circulate the refrigerant for 5 minutes.
 4. Open the ball valve. Recover the purge/sweep charge using the recovery pump and the refrigerator compressor until a 20-in. vacuum is attained. Close the ball valve and remove the recovery hose.
 5. Charge the system with the exact amount of R-134a refrigerant specified.
 6. Disconnect the power cord to the refrigerator. This allows the pressure to equalize. After 3 to 5 minutes, the low side pressure will be positive and then the hose-to-charging port can be disconnected.
 7. Using an electronic leak detector, check all brazed joints and both schrader ports. Reinstall caps to schrader.

Airflow

The evaporator fan forces air through the evaporator into the freezer compartment.

Air from the evaporator can also pass through the electronic damper to the air tunnel outlet, through the fresh food compartment, and return to the evaporator.

The damper is controlled by the main control board. When open, the damper allows the chilled air from the freezer to move into the fresh food compartment.

Air returns from the fresh food compartment to the freezer compartment via two vents located to the left and right of the electronic damper.

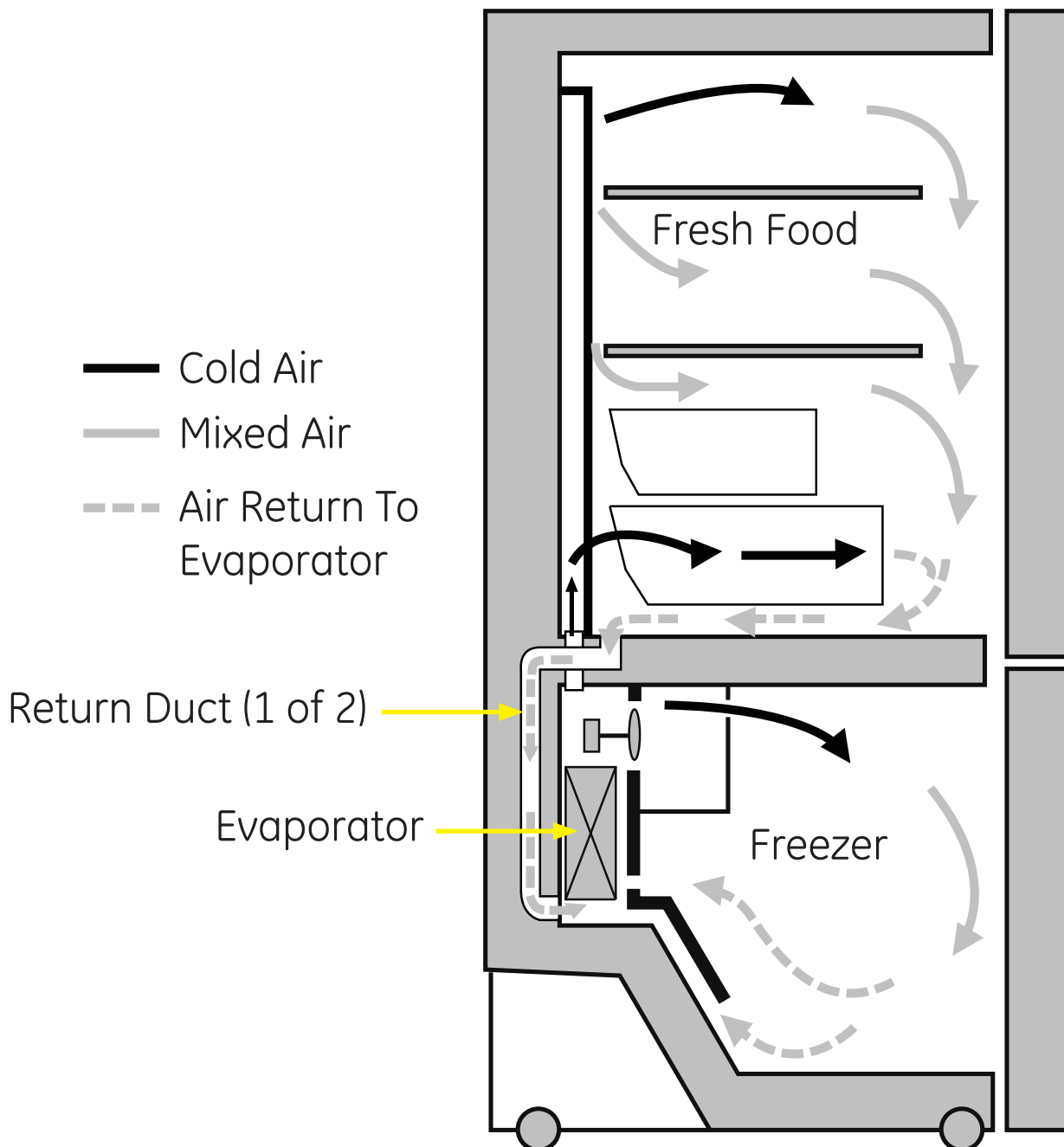

Components

Fresh Food Shelves and Bins

Note: Not all features are on all models.

Rearranging the Shelves

Shelves in the refrigerator compartment are adjustable.

Refrigerator Compartment

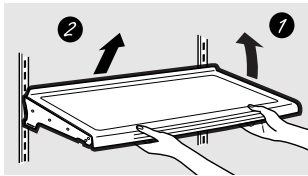

Some models have wire shelves that can be adjusted in the same manner.

To remove:

- 1 Remove all items from the shelf.
- 2 Tilt the shelf up at the front.
- 3 Lift the shelf up at the back and bring the shelf out.

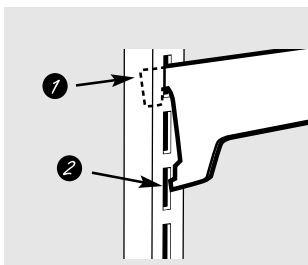

To replace:

- 1 While tilting the shelf up, insert the top hook at the back of the shelf in a slot on the track.
- 2 Lower the front of the shelf until the bottom of the shelf locks into place.

Spillproof Shelves (on some models)

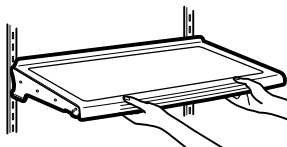

Spillproof shelves have special edges to help prevent spills from dripping to lower shelves. To remove or replace the shelves, see *Rearranging the Shelves*.

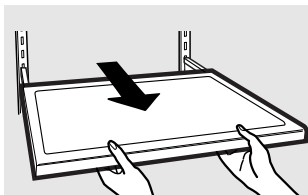

Slide-Out Spillproof Shelf (on some models)

The slide-out spillproof shelf allows you to reach items stored behind others. The special edges are designed to help prevent spills from dripping to lower shelves.

To remove:

- 1 Remove all items from shelf.
- 2 Slide the shelf out until it stops.
- 3 Lift the front edge of the shelf until the central tabs are above the front bar.
- 4 Continue pulling the shelf forward until it can be removed.

To replace:

- 1 Place the rear shelf tabs just in front of the central notches on the shelf frame.
- 2 Slide the shelf in until the central tabs are slightly behind the front bar.
- 3 Lower the shelf into place until it is horizontal and slide the shelf in.

Make sure that the shelf sits flat after reinstallation and doesn't move freely from side to side.

Make sure you push the shelves all the way in before you close the door.

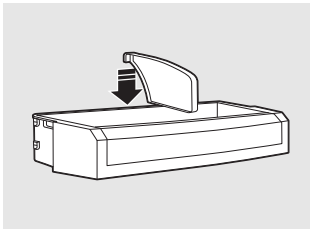

Adjustable Bins on the Door

Adjustable bins can easily be carried from refrigerator to work area.

To remove: Lift bin straight up, then pull out.

To replace or relocate: Slide in the bin just above the molded door supports, and push down. The bin will lock in place.

The snugger helps prevent tipping, spilling or sliding of small items stored on the door shelf. Grip the finger hold near the rear of the snugger and move it to fit your needs.

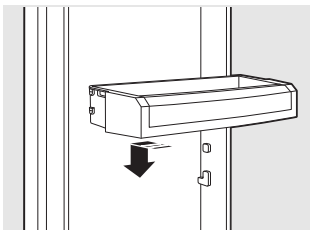

Non-Adjustable Bins on the Door

To remove: Lift the bin straight up, then pull out.

To replace: Engage the bin in the molded supports on the door and push down. It will lock in place.

About the additional features.

Not all features are on all models.

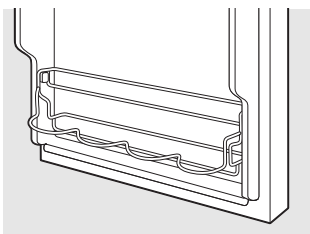

Non-Adjustable Beverage Rack

To remove: Lift the rack straight up, then pull out.

To replace: Engage the rack in the molded supports on the door and push down. It will lock in place.

Fresh Food Crispers and Pans

Note: Not all features are on all models.

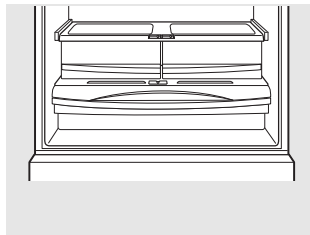

Fruit and Vegetable Crisper

Excess water that may accumulate in the bottom of the drawers or under the drawers should be wiped dry.

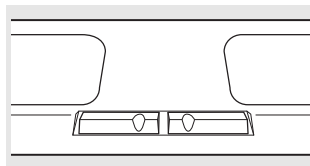

Adjustable Humidity Crisper (on some models)

Slide the control all the way to the **HIGH** setting to provide high humidity recommended for most vegetables.

Slide the control all the way to the **LOW** setting to provide lower humidity levels recommended for most fruits.

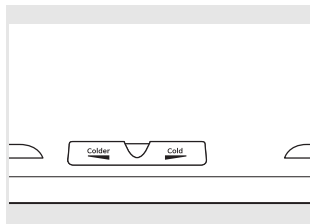

Adjustable Temperature Deli Pan (on some models)

Slide the control all the way to the left for the coldest temperature.

How to Remove and Replace the Deli Pan

To remove:

- 1 Remove the fruit and vegetable drawers.
- 2 Pull the drawer out to the stop position.

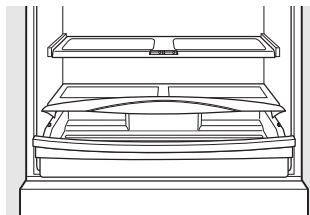

- 3 Lift the lid to access the 4 swing locks.

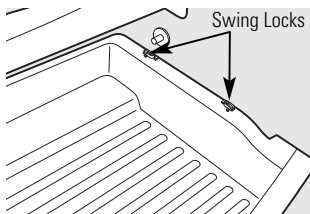

- 4 Rotate all four swing locks to the unlock position.
- 5 Lift the front of the drawer up and out.

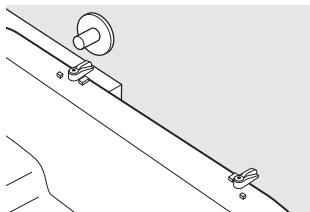

To replace:

- 1 Make sure all four swing locks are in the unlock position.
- 2 Place the sides of the drawer into the drawer supports, making sure the swing locks fit on the drawer slots.
- 3 Lock all four swing locks by rotating them to the lock position.

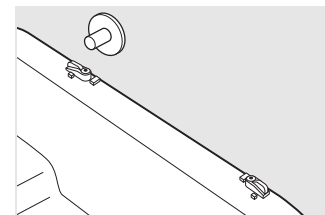

- 4 Lower the lid and slide in the drawer.
- 5 Replace the fruit and vegetable drawers.

Freezer Shelves and Baskets

Note: Not all features are on all models.

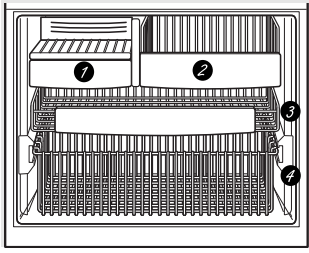

Appearance and features may vary

Freezer Shelves and Baskets

- 1 A shelf above the ice storage bin
- 2 A half-width basket
- 3 A shallow full-width basket
- 4 A deep full-width basket

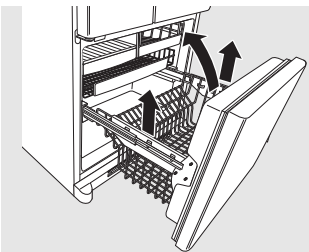

Appearance may vary

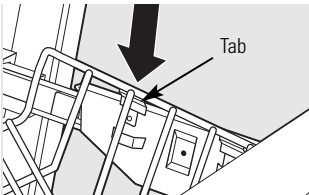

Basket Removal

To remove the deep full-width basket on freezer drawer models:

- 1 Open the freezer drawer until it stops.
- 2 The freezer basket rests on the inside tabs on the drawer slides.
- 3 Lift the basket so that all 4 tabs are out of the slide bracket.
- 4 Tilt the basket and lift out of the drawer.
- 5 Make sure the plastic sleeves remain attached to the 4 tabs on the slide brackets.

When replacing the deep full-width basket:

Tilt the basket back and lower it down into the drawer. Rotate the basket to a horizontal position and press it down into the 4 alignment tabs.

NOTE: Always be sure that all 4 basket tabs are engaged in the slide brackets before sliding back into the freezer.

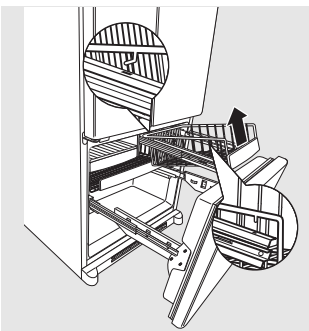

Appearance may vary

To remove the half-width basket:

- 1 Pull the basket out to the stop location.
- 2 Lift the basket up at the front to release it from the slides.
- 3 Lift the back up and out of the slide.

When replacing the basket, make sure that the wire tabs and wire hooks on the sides of the basket go into the slots in the top of the upper basket slides.

NOTE: Always be sure to fully close this basket.

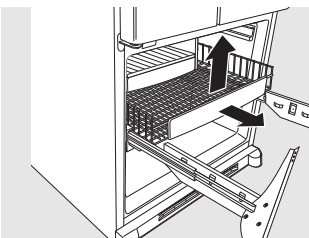

Appearance may vary

To remove the shallow full-width basket:

- 1 Pull the basket out to the stop location.
- 2 Lift the front up and over the stop location.
- 3 Lift the basket up and out.

Thermistors

Thermistor Resistance		
Temperature (°F)	Temperature (°C)	Resistance in Kilo-Ohms
-40	-40	166.8 kΩ
-31	-35	120.5 kΩ
-22	-30	88 kΩ
-13	-25	65 kΩ
-4	-20	48.4 kΩ
5	-15	36.4 kΩ
14	-10	27.6 kΩ
23	-5	21 kΩ
32	0	16.3 kΩ
41	5	12.7 kΩ
50	10	10 kΩ
59	15	7.8 kΩ
68	20	6.2 kΩ
77	25	5 kΩ
86	30	4 kΩ
95	35	3.2 kΩ
104	40	2.6 kΩ
113	45	2.2 kΩ
122	50	1.8 kΩ
131	55	1.5 kΩ
140	60	1.2 kΩ

Note: To accurately test a thermistor, place the thermistor in a glass of ice and water (approximately 33°F) for several minutes and check for approximately 16K Ω.

Ambient Thermistor

The ambient thermistor is located under the freezer compartment and connected at J1-2 on the main control board. (See *Component Locator Views*.) It assists the main control board in compensating for room ambient that is higher or lower than 60°F.

For example, in ambient below 60°F, the fresh food temperature control will shut down properly. The cooler room ambient assists in keeping fresh food temperatures at the preset temperature. However, the compressor does not get enough run time to bring the freezer down to 0°F.

At lower room temperatures, the ambient thermistor alters the main control board's calculations for the target temperature. The main control board then runs the compressor at higher speeds to get the freezer, as well as the fresh food, to an acceptable temperature.

If the external thermistor is not functioning, the main control board default will assume the ambient temperature is 90°F and there will be no adjustment to the fresh food or freezer set point.

The ambient thermistor is attached to the front of the cabinet (under the left side of the freezer compartment) with a plastic wire tie.



Fresh Food and Freezer Thermistors

The fresh food thermistor is located in the left wall of the fresh food compartment. The freezer thermistor is located in the right wall of the freezer compartment.

Note: The fresh food and freezer thermistors are removed in the same manner.

To remove the thermistor cover, insert a flat-blade screwdriver under the front of the cover and gently lift the bottom edge until it releases from the compartment wall.

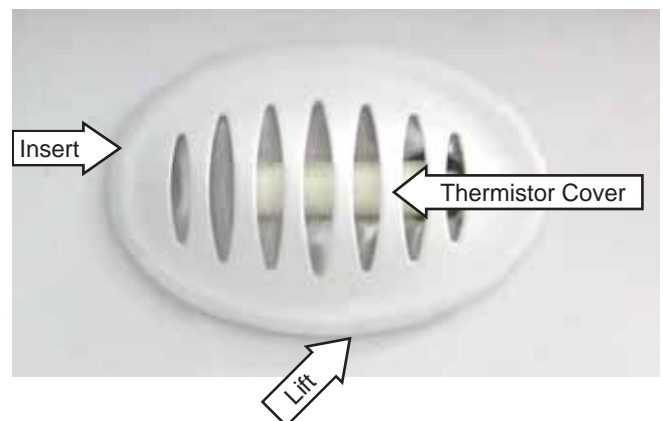

(Continued next page)

Evaporator Thermistor

The evaporator thermistor is clipped to the suction tube line of the evaporator. See *Evaporator* for accessing instructions.

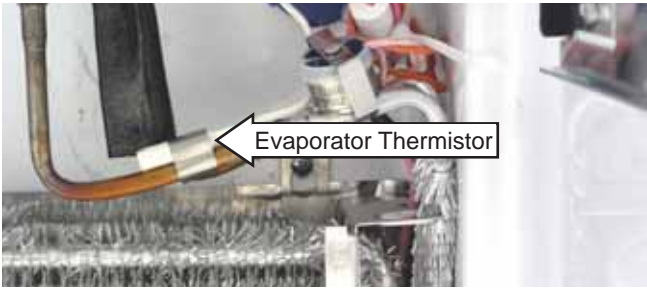

Replacement

Should a thermistor require replacement, use plastic bell connectors (part # WR01X10466). Fill each connector with RTV102 silicone then splice a new thermistor into the harness as shown in the illustration.

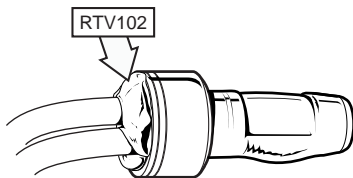

Fresh Food and Freezer Light Thermostats

The fresh food and the freezer light thermostats interrupt power to the lights when the thermostat temperature reaches 175°F. Power is restored when the thermostat temperature cools to 155°F.

Each thermostat is attached to the back of each light housing with an 11/32-in. nut.

To access each thermostat, remove the light cover and light housing. The fresh food light housing is held in place by 3 Phillips-head screws. The freezer light housing is held in place by a single Phillips-head screw.

Note: It is necessary to remove the freezer light bulb to access the freezer light housing screw.

Replacement

Should a thermostat require replacement, use plastic bell connectors (part # WR01X10466). Fill each connector with RTV102 silicone then splice a new thermostat into the harness.

Evaporator Fan

The position of the fan blade in relation to the shroud is important.

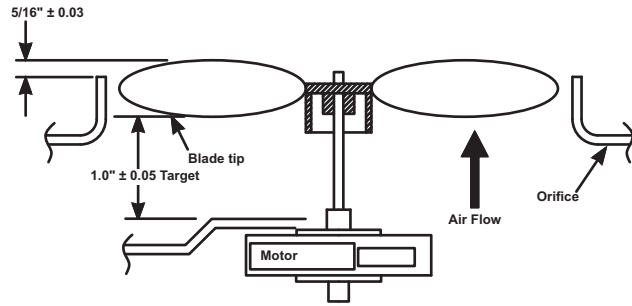

The evaporator fan is the same fan used on previous models; however, a significant difference is that the main control board neither requires nor receives input from the fan feedback/rpm (blue) wire. The fan utilizes a permanent magnet, 4-pole, DC motor that operates at three different speeds: high, medium, and low.

The speed of the fan is controlled by the voltage output from the main control board. Voltage output from the main control board to the fan is 13.6 VDC; however, to regulate the speed of the fan, the main control board uses pulse width modulation (PWM).

When operating, voltage is sent in pulses (much like a duty cycle) as opposed to an uninterrupted flow. This pulsing of 13.6 VDC produces effective voltage being received at the motor, which is equivalent to a reduction in voltage.

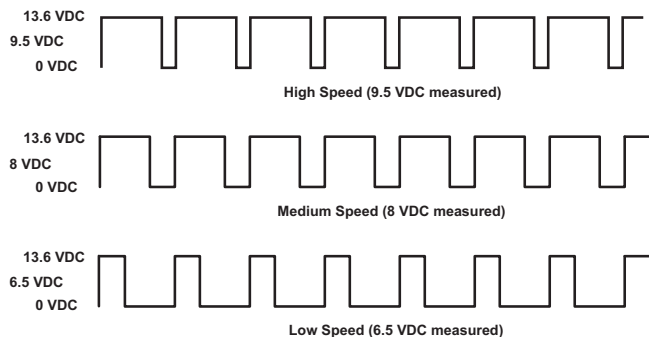

(Continued next page)

Fan speed is selected and maintained by the main control board regulating the length and frequency of the 13.6 VDC pulse. Temperature can cause some fan speed variation. Fan speed can vary +/- 5%, depending on the temperature, with higher temperatures causing slightly higher speeds.

The evaporator fan has a 4-wire connection:

White Wire (DC Common)

The white wire is the DC common wire used for testing. During repairs, DC polarity must be observed. Reversing the DC polarity causes a shorted motor and/or board.

Red Wire (Supply)

Each motor uses an internal electronic controller to operate the motor. Supply voltage from the main control board remains at a constant 13.6 VDC.

Blue Wire (Feedback/RPM)

On previous Arctica models, the blue wire reported rpm (speed) information to the main control board for speed control purposes. On this model, the board does not require or read any feedback information from the fan motor.

Yellow Wire (Signal)

The yellow wire is the input wire from the main control board. The main control board provides 6.5 VDC effective voltage for low speed, 8 VDC effective voltage for medium speed, and 9.5 VDC effective voltage for high speed. The fan operates in low speed only when the fresh food thermistor is satisfied.

Note: When testing these motors:

- You cannot test with an ohmmeter.
- DC common is not AC common.
- Verify 2 voltage potentials:
 - a. Red to white - power for internal controller
 - b. Yellow to white - power for fan
- Observe circuit polarity.
- Motors can be run for short periods using a 9 volt battery. Connect the white wire to the negative (-) battery terminal only. Connect the red and yellow wires to the positive (+) battery terminal.

Condenser Fan

The fan is mounted in the machine compartment with the no-clean condenser. The fan and fan shroud are mounted on one end of the condenser, and the other end of the condenser is blocked.

When the fan is operating, air is pulled from the center of the condenser, drawing air in through the coils. The air is then exhausted over the compressor and out the right side of the refrigerator.

Inlet air is available through the left front and left rear of the machine compartment. A rubber divider strip underneath the refrigerator divides the inlet and outlet sides of the machine compartment.

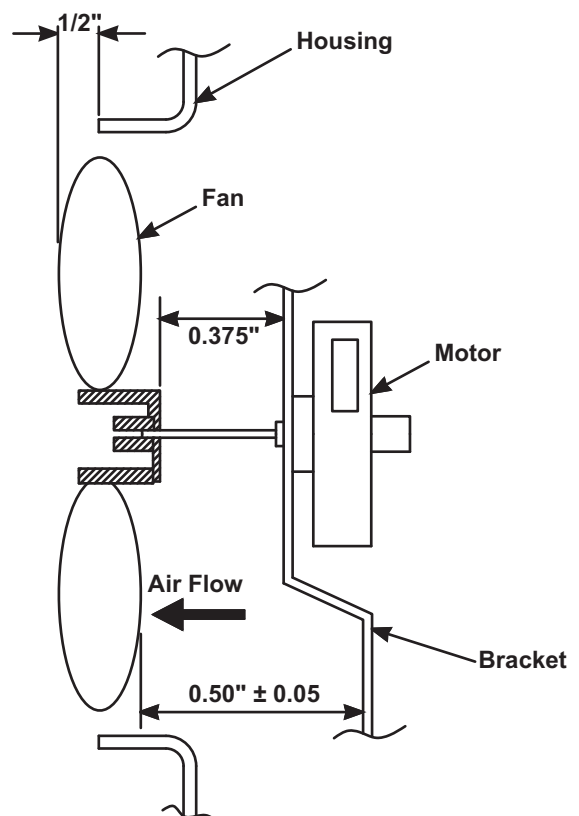
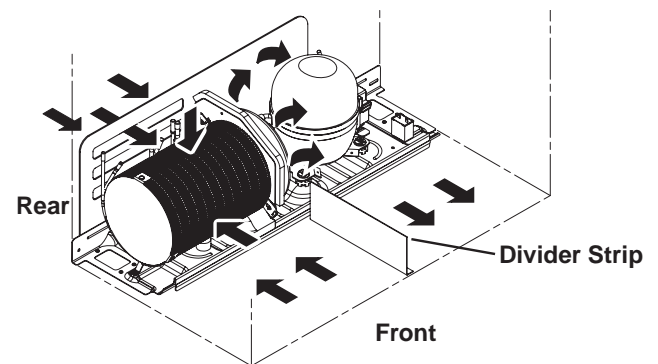

(Continued next page)

The rear access cover must be tightly fitted to prevent air from being exhausted directly out of the rear of the machine compartment, bypassing the compressor.

The condenser fan is mounted with screws to a fan shroud and mounting bracket that is attached to the condenser.

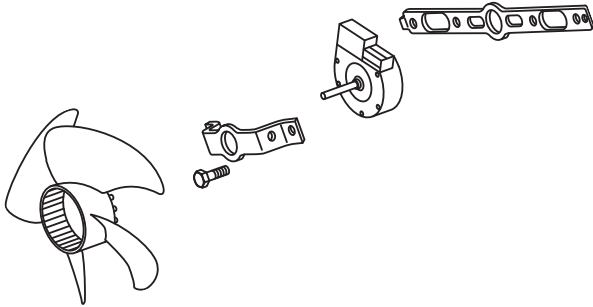

Condenser fan speed corresponds with compressor speed (low, medium, high) to minimize pressure variations in the sealed system except when the freezer temperature is 20°F above the set point. If this condition exists (such as during initial startup), the condenser fan operates at super high speed while the compressor operates at medium speed.

The speed of the fan is controlled by the voltage output from the main control board. Voltage output from the control board to the fan is 13.6 VDC; however, to regulate the speed of the fan, the main control board uses pulse width modulation (PWM).

When operating, voltage is sent in pulses (much like a duty cycle) as opposed to an uninterrupted flow. This pulsing of 13.6 VDC produces effective voltage being received at the motor, which is equivalent to a reduction in voltage.

Fan speed is selected and maintained by the main control board regulating the length and frequency of the 13.6 VDC pulse.

Temperature can cause some fan speed variation. Fan speed can vary +/- 5%, depending on the temperature, with higher temperatures causing slightly higher speeds.

Condenser fan speed is controlled by Pulse Width Modulation (PWM), the same method used to control fan speeds for the evaporators.

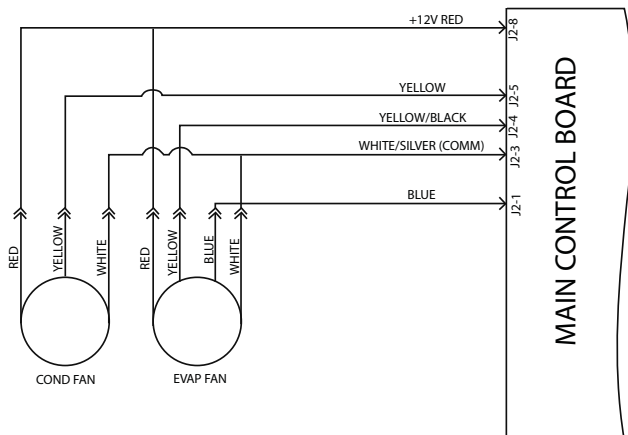
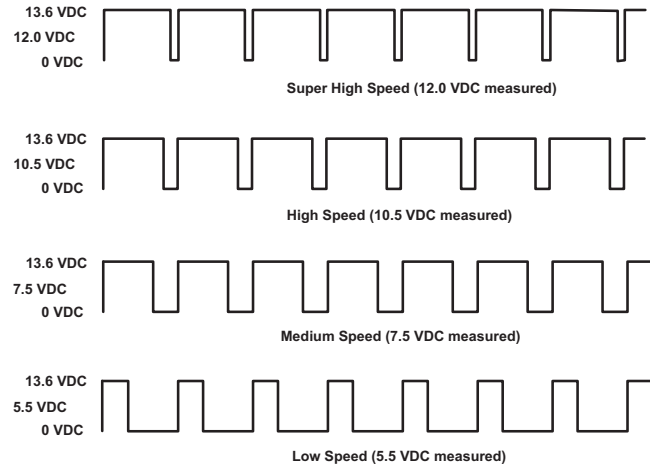

Inverter

The inverter is accessed from the back of the refrigerator and is located on the left side of the compressor behind the water valve. The water valve and the EMI filter (if utilized) must be removed to access the inverter.

To remove the Inverter:

1. Remove the ¼-in. hex-head screw that holds the water valve and the ⅝-in. hex-head screw that holds the EMI filter to the cabinet.

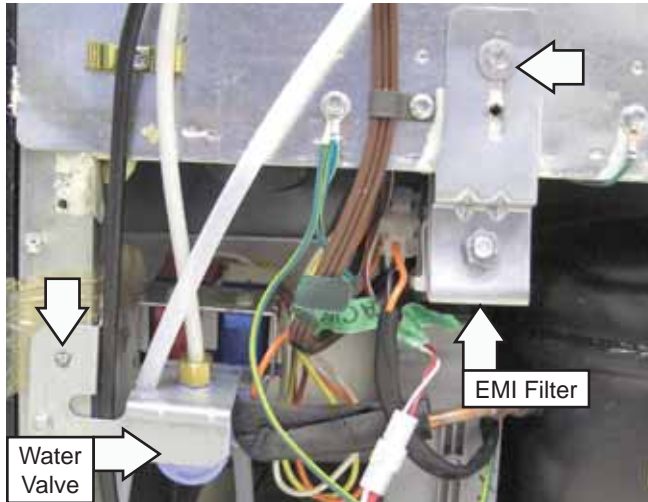

2. Carefully pull the water valve and the EMI filter out from the cabinet.
3. Disconnect the 2 wire harnesses to the inverter.
4. Remove the ¼-in. hex-head screw and the inverter ground wire from the cabinet.

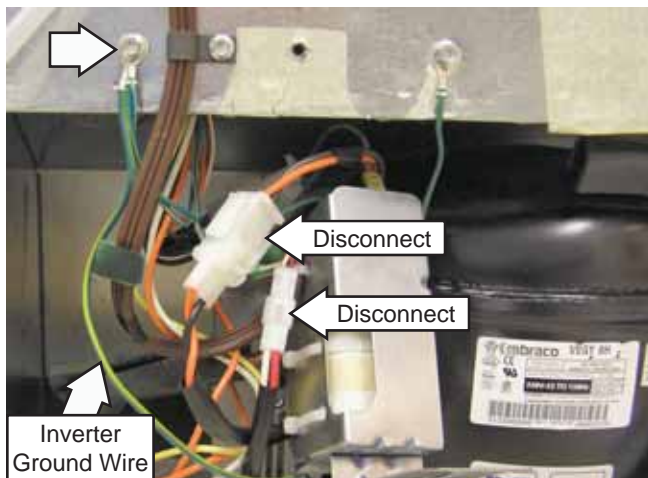

Note: The inverter is attached to the compressor by a lip above the compressor terminals, a tab (located at the bottom rear corner), and a Phillips-head screw.

5. Remove the Phillips-head screw from the inverter.

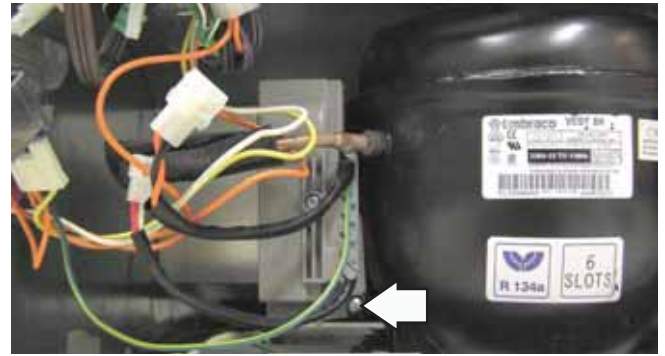

6. Lift and rotate the inverter counterclockwise.
7. Disconnect the compressor harness from the compressor terminals.

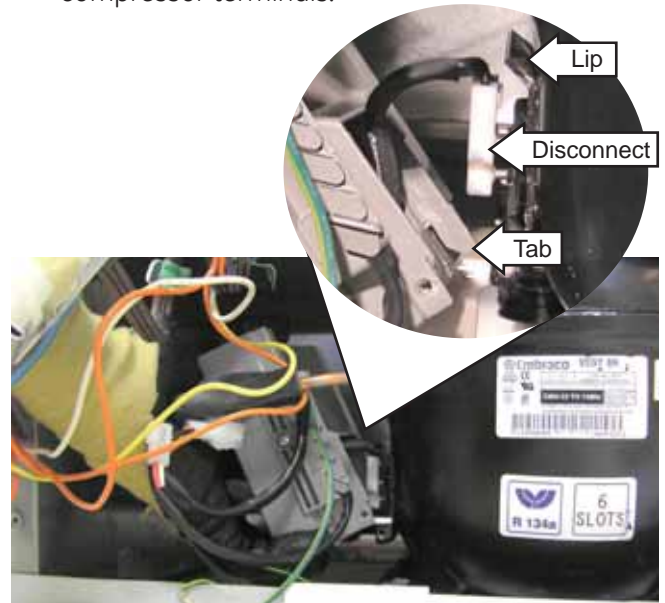

WARNING: When the refrigerator is plugged in, 120 VAC is always present at the inverter.

Note: Certain voltmeters will not be able to read voltage output from the inverter. If no voltage or erratic voltage is measured, it does not necessarily indicate a faulty inverter.

The inverter receives 120 VAC line-in from the power supply. The inverter converts this single-phase, 60 Hz, 120 VAC into 3-phase, 230 VAC, with frequency variations between 57 Hz and 104 Hz. This voltage is delivered to the compressor through 3 lead wires. Each wire will carry identical voltage and frequency.

Note: The compressor leads must be connected to measure voltage output. If the compressor wires are not connected, or if an open occurs in one of the 3 lead wires or in the compressor, the inverter will stop voltage output.

(Continued next page)

When checking inverter voltage output, connect the test-meter leads to any 2 of the 3 compressor lead wires at the inverter plug (plug should be connected). The same reading should be measured between any 2 of the 3 wires.

The inverter controls compressor speed by frequency variation and by Pulse Width Modulation (PWM). Changing frequency and PWM will cause an effective voltage between 80 and 230 VAC to be received at the compressor.

- Low speed (1710 rpm) - 57 Hz
- Medium speed (2100 rpm) - 70 Hz
- High speed (3120 rpm) - 104 Hz

The inverter receives commands from the main control board. The main control board will send a PWM run signal from the J15 connector of between 4-6 VDC effective voltage to the inverter (all wires must be connected). The inverter will select compressor speed (voltage output) based on this signal.

The main control board will only send a run signal to the inverter when the compressor should be on.

Note: When measuring signal voltage (from the main control board) at the inverter, a reading of 4-6 VDC will be measured with all wires connected. If the inverter wiring is disconnected, the board output will measure between 10-12 VDC.

The inverter will monitor compressor operation and if the compressor fails to start or excessive current draw (4 amps maximum) is detected, the inverter will briefly stop voltage output. The inverter will then make 12 consecutive compressor start attempts (once every 12 seconds). After 12 attempts, if the compressor has not started, an 8-minute count will initiate. After the 8-minute count, the inverter will attempt to start the compressor again. If the compressor starts, normal operation will resume. If the compressor fails to start, this process will be repeated. Removing power to the unit will reset the inverter count. When power is restored, the inverter will attempt to start the compressor within 8 seconds.

The inverter has a built-in circuit protection to guard against damage from a failed or shorted compressor. However, if a failed compressor is diagnosed, order a new compressor and inverter. If the compressor fails to start after replacement, replace the inverter.

Inverter Compressor

Caution: Do not attempt to direct-start the compressor. The compressor operates on a 3-phase power supply. Applying 120 VAC to the compressor will permanently damage the unit. It is not possible to start the compressor without an inverter.

The compressor is a reciprocating, variable speed, 4-pole type. It operates on 3-phase, 80 to 230 VAC within a range of 57 to 104 Hz.

Note: Certain voltmeters will not be able to read voltage output or frequency from the inverter.

Compressor wattages at various speeds are:

- LOW - 65 watts
- MED - 100 watts
- HIGH - 150 watts

The compressor is controlled by the inverter, which receives its signal from the main control board. Varying the frequency to the inverter changes the compressor speed.

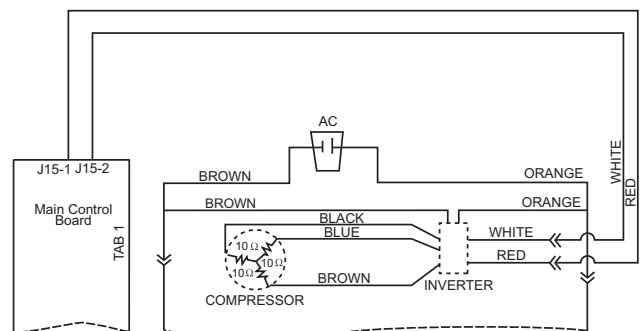

Compressor speed is based on the temperature set point in conjunction with the specific cabinet temperature. Speeds are selected according to the following cabinet temperatures, with freezer temperature being the primary:

- 7°F to 19.5°F above freezer set point = high speed.
- 4.5°F to 6.5°F above freezer set point = medium speed.
- 1°F to 4°F above freezer set point = low speed.
- 1°F to 2.5°F above refrigerator set point = low speed.

(Continued next page)

- 3°F to 5°F above refrigerator set point - medium speed.
- 5.5°F to 7°F above refrigerator set point - high speed.

Note: The compressor will run at medium speed if the freezer temperature is 20°F or more above the setpoint.

The use of 3-phase power eliminates the need for the relay, capacitor, and individual start and run windings; therefore, the start, run, and common pins found on conventional compressors are not applicable on this 3-phase model. Compressor pin functions are identical and compressor lead wire configuration is of no importance. A resistance of 9 Ω to 11 Ω should be read between any 2 of the 3 pins. Should an open occur in the compressor winding or should one of the compressor lead wires become open or disconnected, the inverter will stop voltage output to the compressor.

High compressor torque enables the compressor to start against high pressure in the sealed system. When power has been disconnected from an operating unit, the high torque will enable the compressor to start immediately upon power restoration.

Compressor operation is extremely smooth and cool. The compressor exterior may be slightly higher than room temperature while operating; therefore, it may be difficult to detect a running unit.

To verify that the compressor is running:

Disconnect power from the unit and place a hand on the compressor. Reconnect power and feel for a vibration when the compressor tries to start. It may take up to 8 seconds before the compressor attempts to start.

Note:

- When ordering a replacement compressor, order both the compressor and inverter. Replace the compressor first. If, after compressor installation, the compressor fails to start, replace the inverter.
- When servicing the compressor, it is important to dress the wiring to keep low voltage DC wiring and 120 VAC wiring separate.

Evaporator

The following components must be removed in the appropriate order to access the evaporator:

1. Unplug the refrigerator.
2. Pull out and remove the ice bin and shelf.
3. Remove the freezer shelves and baskets. (See *Freezer Shelves and Baskets*.)
4. Loosen the top two 3/8-in. hex-head screws 1 full turn, then remove the remaining eight 3/8-in. hex-head screws that attach the drawer front to the rail assemblies.

Note: Do not remove the torx screws from the rail assemblies.

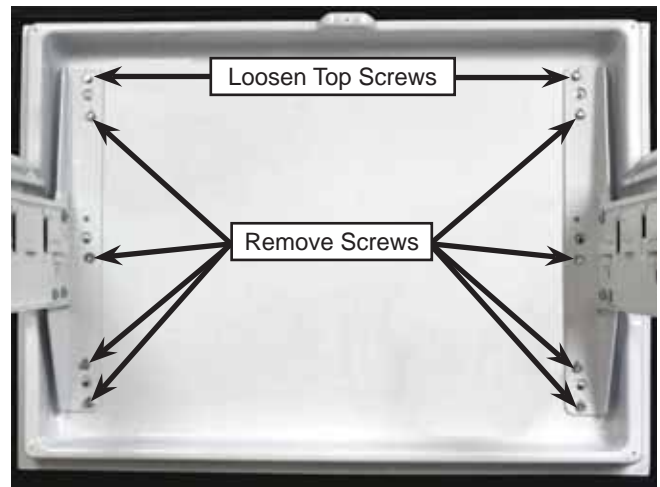

5. Lift and remove the drawer front and place it on a protected surface.

Note: To ensure correct alignment when installing the drawer front, place the top two 3/8-in. hex-head screws into the open slots on top of each rail assembly, then install the center screws.

Install the remaining six 3/8-in. hex-head screws, then tighten all screws firmly. Check drawer operation.

Note: The top of the vertical divider is inserted in a molded recess in the freezer ceiling. The bottom of the divider has a front and rear tab that are captured in a notch in each of the 2 support rails.

6. Remove the vertical divider from the support rails:
 - a. Release the front of the vertical divider by pressing down on the front support rail while pressuring the front of the divider up.

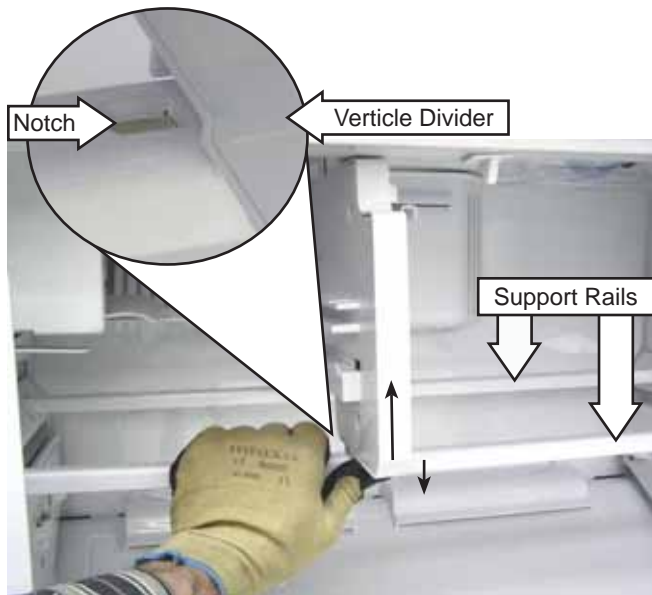

- b. Carefully rotate the divider slightly counterclockwise to clear the tab from the notch in the rail.
 - c. Repeat the above procedure to release the rear of the divider from the rear support rail.

Note: When installing the vertical divider, position the top of the divider into the recess in the freezer ceiling before positioning the bottom over the notches in the support rails.



7. Remove the two ¼-in. hex-head screws that attach the icemaker to the freezer wall.

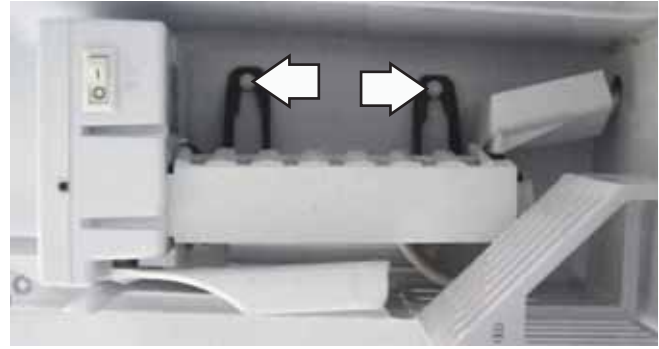

8. Using a small flat-blade screwdriver, expand the 2 clips and disconnect the icemaker wire harness.



9. Remove the two ¼-in. hex-head screws that attach the icemaker bin support to the left freezer wall.

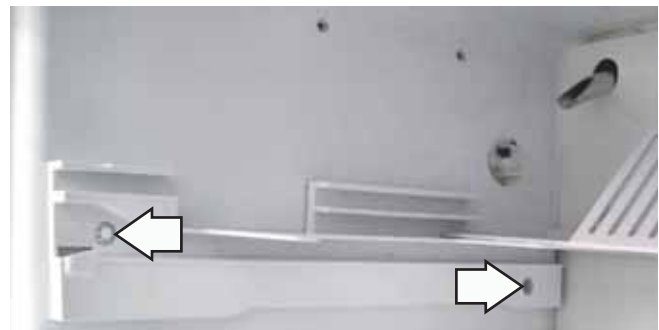

Note: The freezer fan cover is attached to the evaporator cover with a Phillips-head screw, 3 cover tabs, and 2 right side hinge tabs.

10. Remove the single Phillips-head screw.

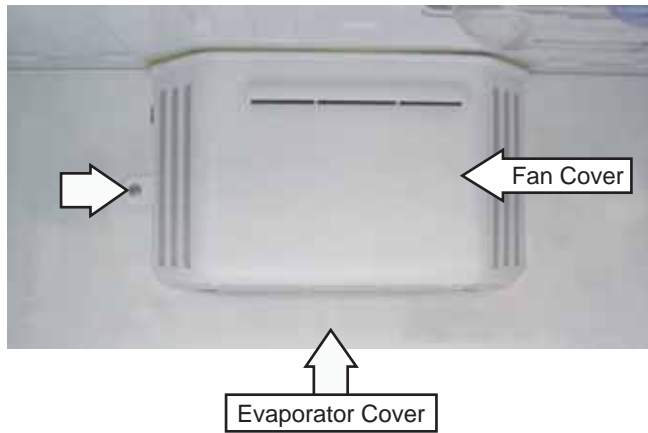

11. Pull the left side of the fan cover out to approximately 90 degrees, then remove the fan cover.

12. Using a flat-blade screwdriver, press in the tab and forcefully lift up one end of each support rail and remove each rail.

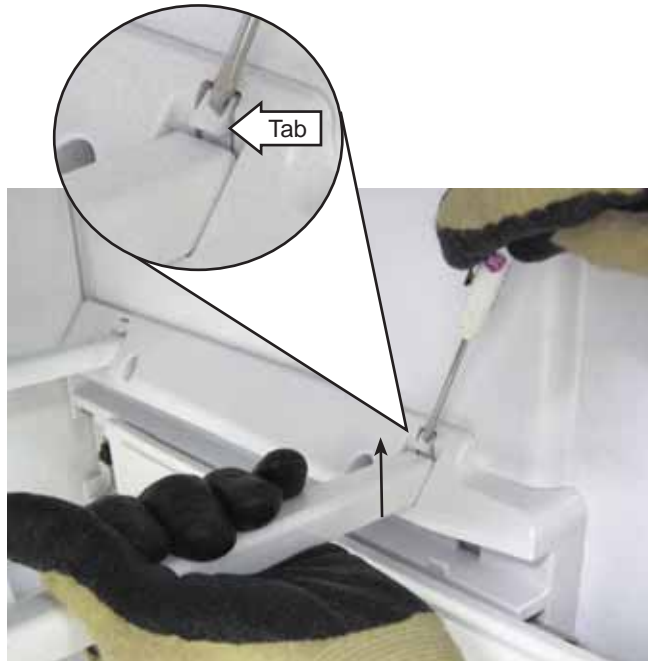

13. Extend each drawer rail fully, then remove the five ¼-in. hex-head screws that attach each drawer rail assembly to the freezer side walls.

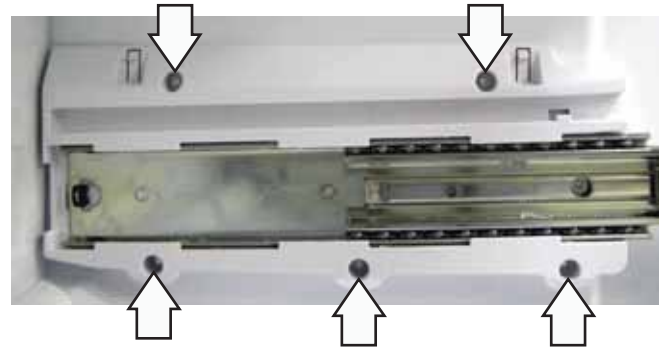

Note: The evaporator cover is attached to the evaporator compartment with two ¼-in. hex-head screws, 3 bottom tabs, and 8 snap tabs located on the back of the cover.

14. Remove the two ¼-in. hex-head screws that attach the evaporator cover to the fan bracket.

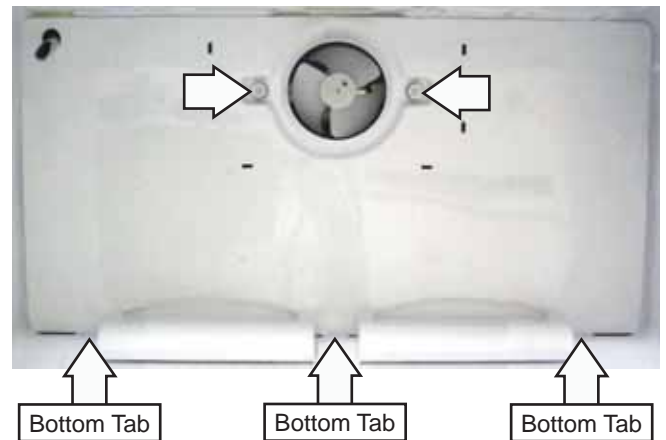

15. Grasp and pull the right side of the fan opening towards the front of the freezer to release the right side snap tabs.



16. Pull out the left side of the cover and carefully remove it from the evaporator compartment.

Defrost Heater

The defrost heater is a single-tube, glass-enclosed radiant heater. It is held in place by 2 tabs on the evaporator (1 on each side) and by a ceramic and wire support.

To remove the defrost heater:

1. Access the freezer evaporator. (See *Evaporator*.)

Note:

- During defrost, the heat conducting clip assists in preventing the drain from icing closed. During assembly, the clip must be installed on the evaporator and inserted in the drain to prevent drain freeze-up.
 - A ceramic and wire support prevents the heater from sagging and touching the metal drain trough if the glass is broken.
2. Remove the ceramic and wire support and the heat conducting clip from the evaporator.

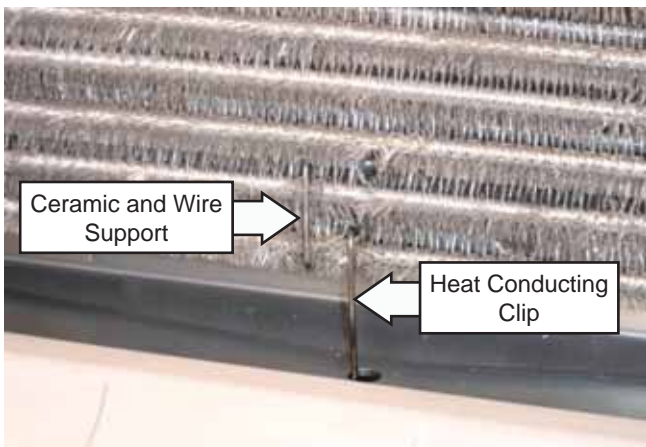

3. Bend the aluminum tabs back (located at each end of the defrost heater) and lower the heater out of the evaporator.
4. Disconnect 2 lead wires and remove the heater.

Icemaker Fill Tube Heater

The fill tube heater is energized during the defrost cycle when the defrost thermostat is closed. Remove the evaporator cover to access the icemaker fill tube heater. (See *Evaporator*.) Disconnect the fill tube heater wire harness. The resistance of the fill tube heater is approximately 2644 Ω .

Return Duct Heaters

A return duct heater has been added to each of the 2 fresh food compartment return air ducts. The heaters prevent water from freezing and blocking the air flow in the ducts. Restricted ducts can cause warm fresh food temperatures. (See *Airflow*.)

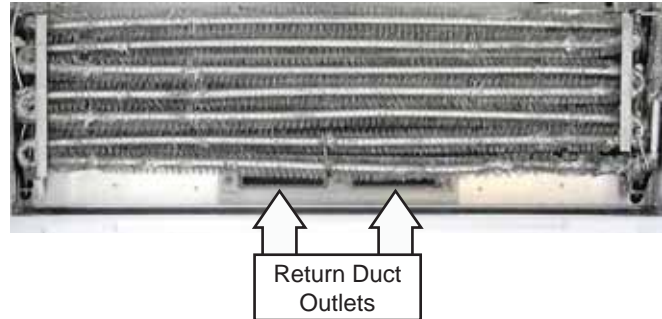

The heaters operate with 120 VAC and each heater has an approximate resistance value of 440 Ω . The heaters are in a parallel circuit consisting of 2 duct heaters, icemaker fill tube heater, and the defrost heater. The line voltage wires of the duct heaters and the fill tube heater are connected to the blue wire of the defrost heater. The neutral wires of the heaters go through the over temperature thermostat. The 2 duct heaters and the fill tube heater are energized (along with the defrost heater) during the defrost cycle when the over temperature thermostat is closed.

Return Duct Heaters Test

If open duct heaters are suspected, perform the following:

1. With the over temperature thermostat closed, test for approximately 27 Ω (the equivalent resistance of this parallel circuit) between J9 and J7-9 .
2. For a resistance reading other than approximately 27 Ω , remove the evaporator cover (See *Evaporator*.), disconnect the fill tube heater, and one lead from the defrost heater. Insert a volt ohm meter into the fill tube heater receptacle. A reading of approximately 220 ohms at 70°F indicates both heaters are good.

Note: The return duct heaters are integral to the foamed in place internal ductwork of the refrigerator and are not replaceable.

Replacing Evaporator Using the Brazing Method

Parts Needed:

- Freezer Evaporator
- Drier Assembly
- Access Tube (part # WJ56X61)
- Heat Shield Kit (part # WX5X8926)

Caution: A heat shield kit is required for this procedure to prevent damage to the plastic interior (liner) of the freezer compartment.

1. Unplug the refrigerator.
2. Remove the rear access cover and evacuate the sealed system.
3. Remove components necessary to expose the evaporator. (See *Evaporator*.)
4. Note the location of the thermistor and over temperature thermostat on top of the old evaporator and remove.
5. Remove heater from bottom of evaporator and discard. Bundle remaining wires and tape high on the back wall of freezer.
6. Apply a liberal amount of thermal paste to suction line where it enters the rear wall of freezer.
7. Insert the brazing shield behind the joints of the evaporator inlet and outlet to protect the liner.
8. Use torch to heat the joints of the evaporator inlet and outlet, separate the joints and clean the suction line and the capillary surface.
9. Loosen the 2 Phillips-head screws that hold the evaporator in place. Note locations of the heat transfer wires at the sides of old evaporator. These are needed to transfer heat to the turns of the evaporator during the defrost cycle. Remove the transfer wires and save for new evaporator installation. Remove the old evaporator.
10. Install the new evaporator and tighten the 2 Phillips-head screws.
11. Connect the evaporator inlet and outlet to the suction line and capillary tubes.
12. Check that the thermal paste is still on the suction line where it enters the rear wall of the freezer. If not, apply paste. In addition, apply thermal paste around epoxy joints on the new evaporator to prevent the heat from damaging joint integrity.
13. Move the brazing shield behind the capillary and suction line joints. Protect the freezer floor from molten solder during brazing.
14. Angle torch so that flame is directed away from rear wall when brazing. Braze suction line and capillary to new evaporator.
15. Remove the brazing shield. Clean and inspect all joints.
16. Remove the old drier by cutting the halo loop as close as possible to the drier. Install the new drier assembly making sure that there is sufficient space between the tubing.
17. Install the access tube. Clean and inspect joints.
18. Replace the heater supplied with the evaporator. Reinstall the over temperature thermostat, thermistor, and heat transfer wires at the sides of new evaporator. Dress wiring.
19. Evacuate and charge the system. Use original factory charge quantity of R-134a. (See *Evacuation and Charging Procedure*.)
20. Replace all component parts in the freezer.
21. Reinstall the rear access cover.

Fresh Food Damper

A damper assembly is used to control airflow from the freezer into the fresh food compartment. It is located on the back wall of the fresh food compartment, behind the deli and crisper drawers. The damper assembly consists of a 12 VDC motorized damper sealed inside the styrofoam air tower, and a plastic cover. The assembly is held in place with one ¼-in. hex-head screw at the top, and 2 pins at the bottom that fit into the liner.

To remove the fresh food damper:

1. Remove the fruit and vegetable crisper drawers and the crisper drawer cover and frame assembly.

Caution: The glass inserted in the deli pan cover and frame may easily separate. Care should be taken when removing the deli pan cover and frame assembly.

2. Partially open the deli pan, lift and remove the deli pan cover and frame.
3. Pull the deli pan out to the fully open position.
4. Remove the ¼-in. hex-head screw from the top of the air tower cover.

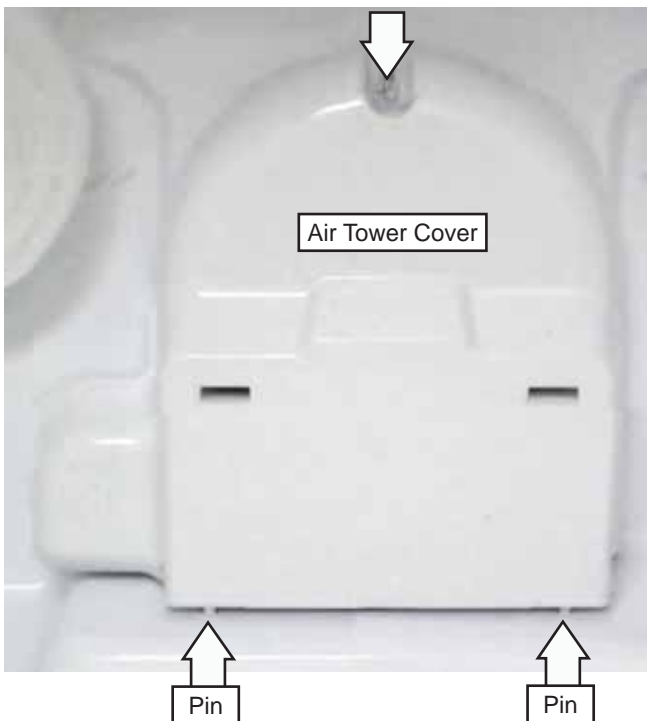

5. Pull up on the damper assembly then remove the air tower cover.



6. Disconnect the damper motor wire harness.
7. Remove the gasket from the bottom of the air tower.

Note: In the following step, care should be taken to prevent damage to the air tower.

8. Carefully cut or peel off the tape that seals the front to the back of the air tower.

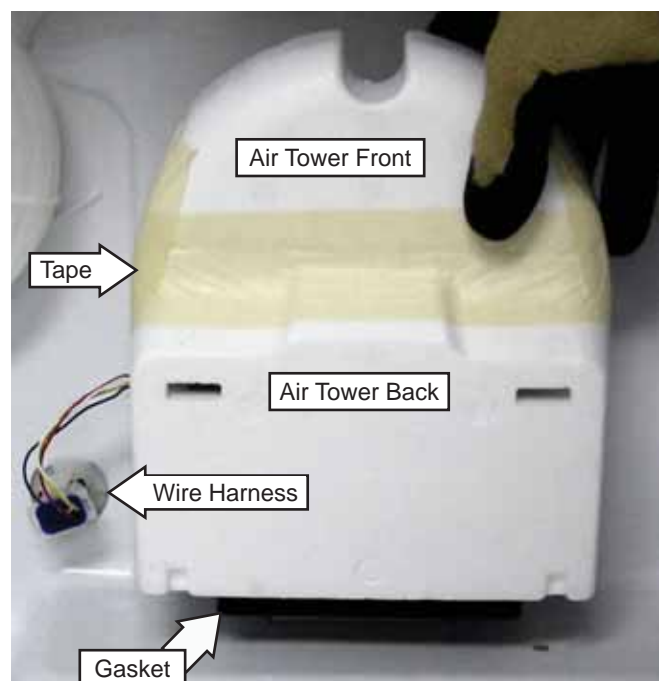

- Separate the styrofoam air tower that houses the damper.



- Remove the damper from the separated styrofoam air tower.

Motorized Damper Removed



Note: To prevent moisture and ice from accumulating in the fresh food compartment:

- It is imperative to properly seal the front to the back of the air tower.
- Ensure the gasket is placed between the bottom of the air tower and the liner.

Articulating Door Mullion (French Door Models)

The articulating door mullion is attached to the right side door, and provides a movable center mullion that maximizes access to the fresh food compartment. With both refrigerator doors closed or only the left side door opened, the mullion stays in position. When the right side door is opened, the spring-loaded mullion is activated to fold against the handle side of the door liner.

The pin on top of the mullion and the track, located at the top center front of the refrigerator, ensure proper mullion bar alignment upon closure of the right side door.

Door Closed -
Pin in Track

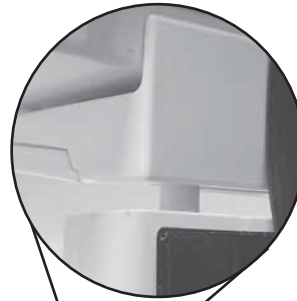

Door Opening -
Pin Exiting Track



The articulating door mullion consists of the mullion, heater, internal spring, and 2 hinges. It is available only as an assembly.

Note: If the Energy Saver light is lit, then the heaters in the vertical and horizontal mullions are disabled.

The heater operates on 13.6 VDC when both doors are closed. It is necessary to close the left side door and close the right side light switch to test for the operating voltage of 13.6 VDC. The resistance of the heater is approximately 4400 Ω .

To replace the articulating door mullion assembly it is necessary to remove the 2 Phillips-head screws from the top and bottom hinges. The wire harness can be pulled out from the recess in the bottom of the door and disconnected.

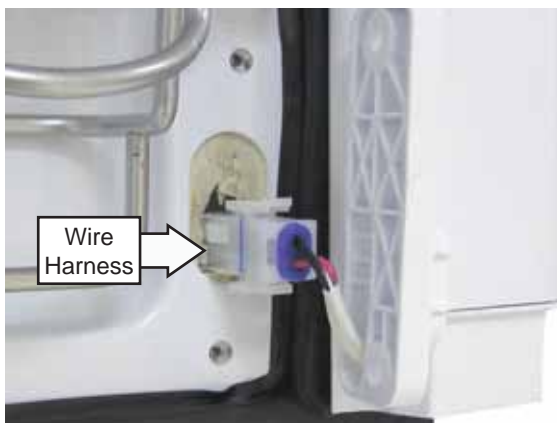
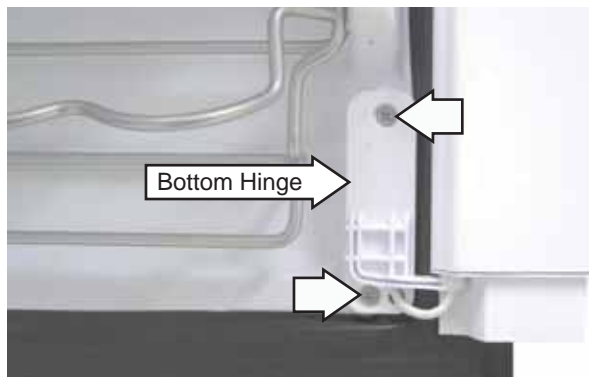
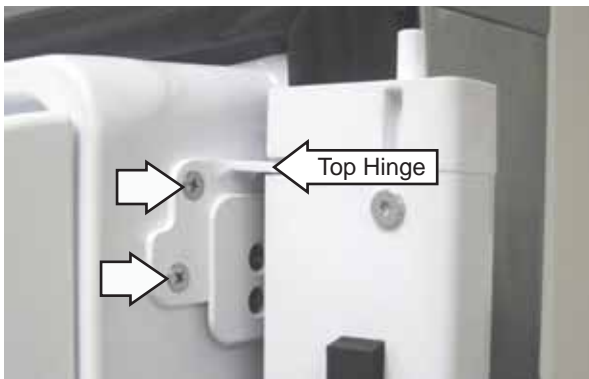

Water Dispenser and Interface

The water dispenser assembly incorporates the interface used for temperature control and features. The interface has 2 tabs that hold it to the cradle support. The tabs are located above 2 slots located behind the bottom of the interface.

To remove the water dispenser assembly:

1. Using a flat-blade screwdriver, push up on each tab, then pry the bottom of the interface away from the dispenser recess.

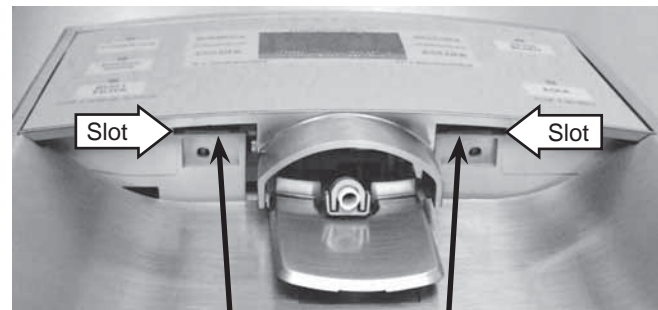

- Carefully lower the interface and disconnect the 2 wire harnesses.
- Remove the 4 Phillips-head screws and the cradle support from the dispenser recess.

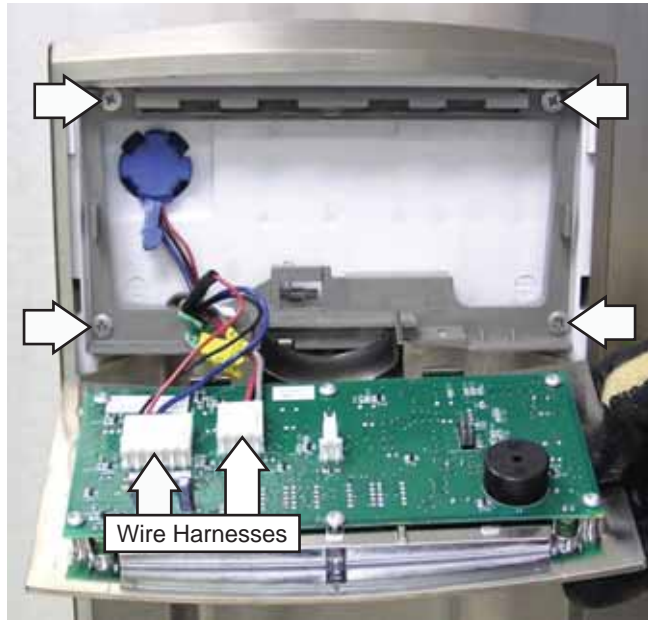

- Lift and remove the drip tray.

Note: There are 2 plastic wedges that help hold the top of the trim flush against the door panel. If the wedges are not installed the trim will fit loosely.

- Using a pair of long-nose pliers, pull out the 2 plastic wedges.

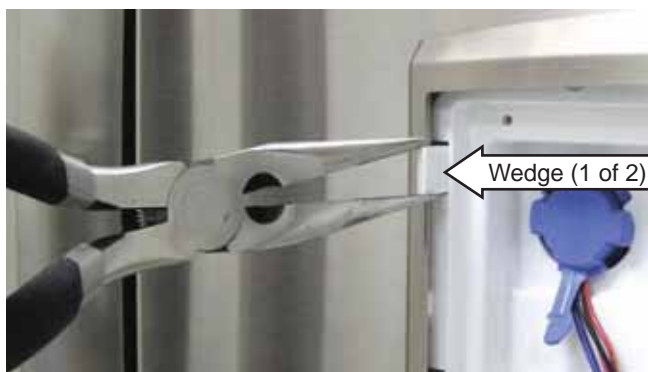

Note: The dispenser trim is held to the dispenser recess by 5 retaining tabs along each side and 2 at the top.

- Using your hands or a plastic putty knife, carefully lift or pry the dispenser trim away from the dispenser recess.



Drawer Closure Mechanisms

Two self closing freezer drawer cam and lever mechanisms automatically pull the drawer shut when it's within 1 inch of the closed position. The closure mechanisms are located on the lower corner areas of the drawer and cabinet.

Each closure mechanism consists of a lever, spring, and cam. The lever is attached with a spring to a hook in the base channel. The cam is mounted to the bottom of the drawer with two T-20 Torx screws. The lever interacts with the cam to complete the closing of the drawer.

A pair of pliers can be used to remove the spring from the hook. The spring and lever can then be pulled out through the hole in the base channel.

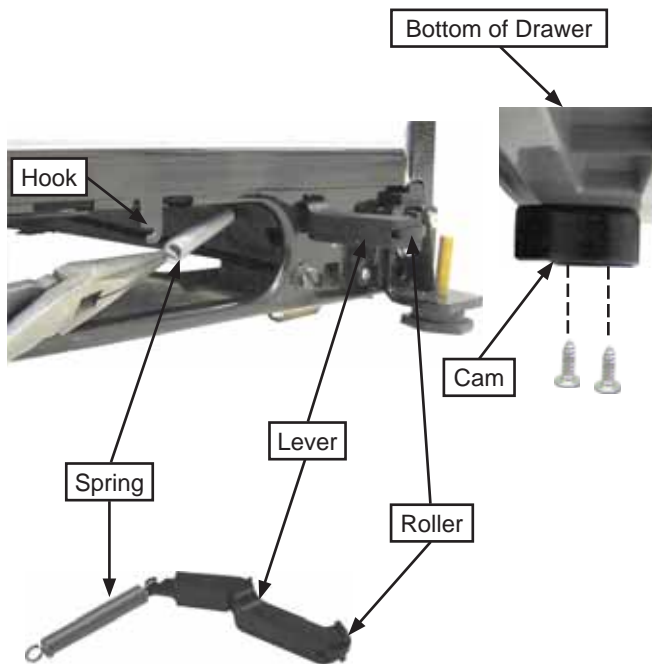

Note: Each door closer cam can be installed incorrectly. Ensure each cam is installed on the bottom of the drawer with the hooked end towards the center of the drawer.

Bottom View of Drawer and Right Side Cam



EMI Filter

The EMI Filter is accessed from the back of the refrigerator and is located on the left side of the compressor.

To remove the EMI filter:

1. Remove the $\frac{5}{16}$ -in. hex-head screw that attaches the bracket to the cabinet.
2. Pull the bracket out and remove the $\frac{1}{2}$ -in. nut.

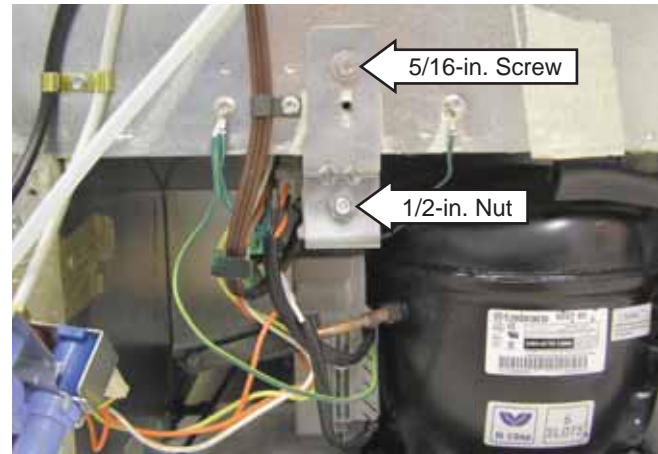

3. Cut the 2 plastic wire ties that hold the EMI filter to the bracket.
4. Mark and disconnect the wires from the EMI filter.

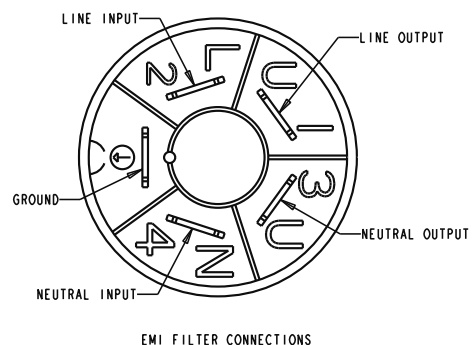
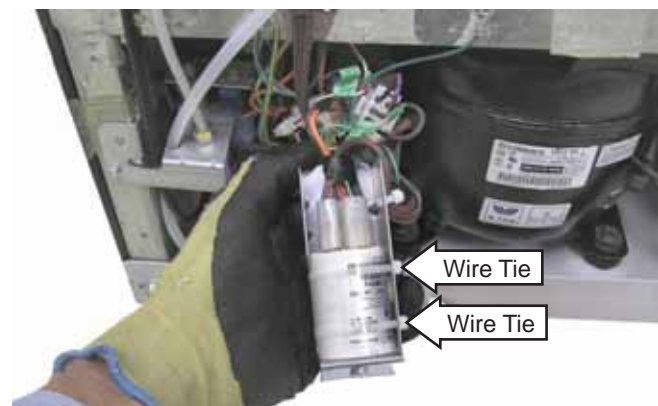

Troubleshooting

Control Diagnostics Using the Temperature Display

The temperature display has a self-diagnosis mode that can be accessed and will help the technician to test certain functions of the temperature display, defrost heater, damper, and interior fans. This mode can aid the service technician in quickly identifying failed or improper operation of certain components and systems.

Control diagnostics using the display does not use error codes to identify problems. Instead, the temperature display allows access to components or systems to be checked if a problem is detected.

The temperature display must be in an active mode before entering the self-diagnosis test. If the display is blank, press any temperature button once, then release it. The display will show actual temperatures.

Enter the diagnostic mode by pressing both the freezer temperature (COLDER and WARMER) pads and the refrigerator temperature (COLDER and WARMER) pads simultaneously. All four pads must be held for approximately 3 seconds. Blinking "00"s in both the freezer and refrigerator sections of the display indicate the refrigerator has entered the test mode. Remove fingers within 5 seconds and press any pad to lock-in the test mode. The blinking "00"s will change over to solid (non-blinking) "0"s when the test mode is locked-in. Failure to lock-in the test mode within 30 seconds will time out the test and return the refrigerator to the normal cooling mode.

FZ Display	FF Display	Mode	Comments
0	1	Showroom Mode	When activated, a tone will sound briefly and the display will flash 1 time. The cooling system stops operation. All HMI functions will operate normally.
0	2	Display Combined HMI Software Version	Temperature to main controls communications test. A coded software version is displayed. Dispenser model will show two numbers. See Note 1. Internal display model will test for Pass/Fail. Should show "P". If the format is violated, the display will read "99".
0	3	Display Main Control Software Version	Temperature to dispenser communications test. A coded software version is displayed. Dispenser model will show two numbers. See Note 1. Internal display model will show "F" (no dispenser board). If the format is violated, the display will read "99".
0	4	Combined HMI to Main communications	Dispenser to main controls communications test. Dispenser model will test for Pass/Fail. Should show "P". Internal display will show "F" (no dispenser board).
0	6	HMI Self Test	Illuminates all LEDs and numerical segments. FF and FZ displays will initially display "88". Pressing temperature pads will change initial display. Remaining pads pressed will toggle the LED associated with that pad. Filter pad repeatedly pressed will toggle red, green, and amber LEDs. To exit HMI Self Test, press and hold both FF temperature pads simultaneously for 3 seconds, then release.
0	7	Sensor Self Test	Checks each thermistor in order and displays "P" for pass, "0" for open circuit, or "S" for shorted circuit. See Note 2.

(Continued next page)

FZ Display	FF Display	Mode	Comments
1	0	Open Damper	Damper will open, pause briefly, and then close.
1	1	Fan Speed Test	Cycles through each fan for 5 seconds.
1	2	100% Run Time	This mode runs the sealed system 100% of the time. This test will automatically time out after 1 hour of run time. A refrigerator reset may exit this mode.
1	3	Enter Pre-chill	This places the freezer in pre-chill mode essentially issuing a "Force Prechill" command to the main control. It will return to normal operation on its own. This command will be ignored if the refrigerator is set to OFF/Standby mode.
1	4	Toggle the State of Defrost	Each time any button on the temperature board other than four temperature adjust buttons is pressed, the status of the FZ defrost heater will toggle. See Note 3.
1	5	Refrigerator Reset	Causes a soft reset to occur at both the Combined HMI and the Main board.
1	6	Test Mode Exit	Causes a soft reset to occur at the Combined HMI board. Note: This will not terminate test modes that the main board is maintaining as a result of the service diagnostics mode. To terminate test modes, Refrigerator Reset should be used.
1	7	Degree C/F	Internal display model only. Used to set the temperature unit of measure. The current mode is displayed on the FF display ("C" or "F"). Use either of the FF slew keys to adjust the mode. Press any key other than the FF slew keys to set the unit of measure to the displayed selection.

Note 1: The first two digits are numbers. The second two digits are numbers that correspond to a letter (01=a, 02=b, 03=c,...26=z). For example, 61 and 9= a software version of 61i. 41 and 10=a software version of 41j.

Note 2: Display order: #1 = Fresh Food Thermistor, #2 = Air Thermistor, #3 = Freezer Thermistor, #4 = Evaporator Thermistor. 05 displayed = No Thermistor installed at this location.

Note 3: The heater will not come on if the evaporator thermistor is above 70°F.

Schematic

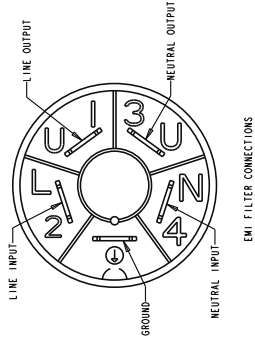

Note: The EMI filter is on all 21' and 25' single and French door models. The 20'/22' single and French door models do not have this filter.

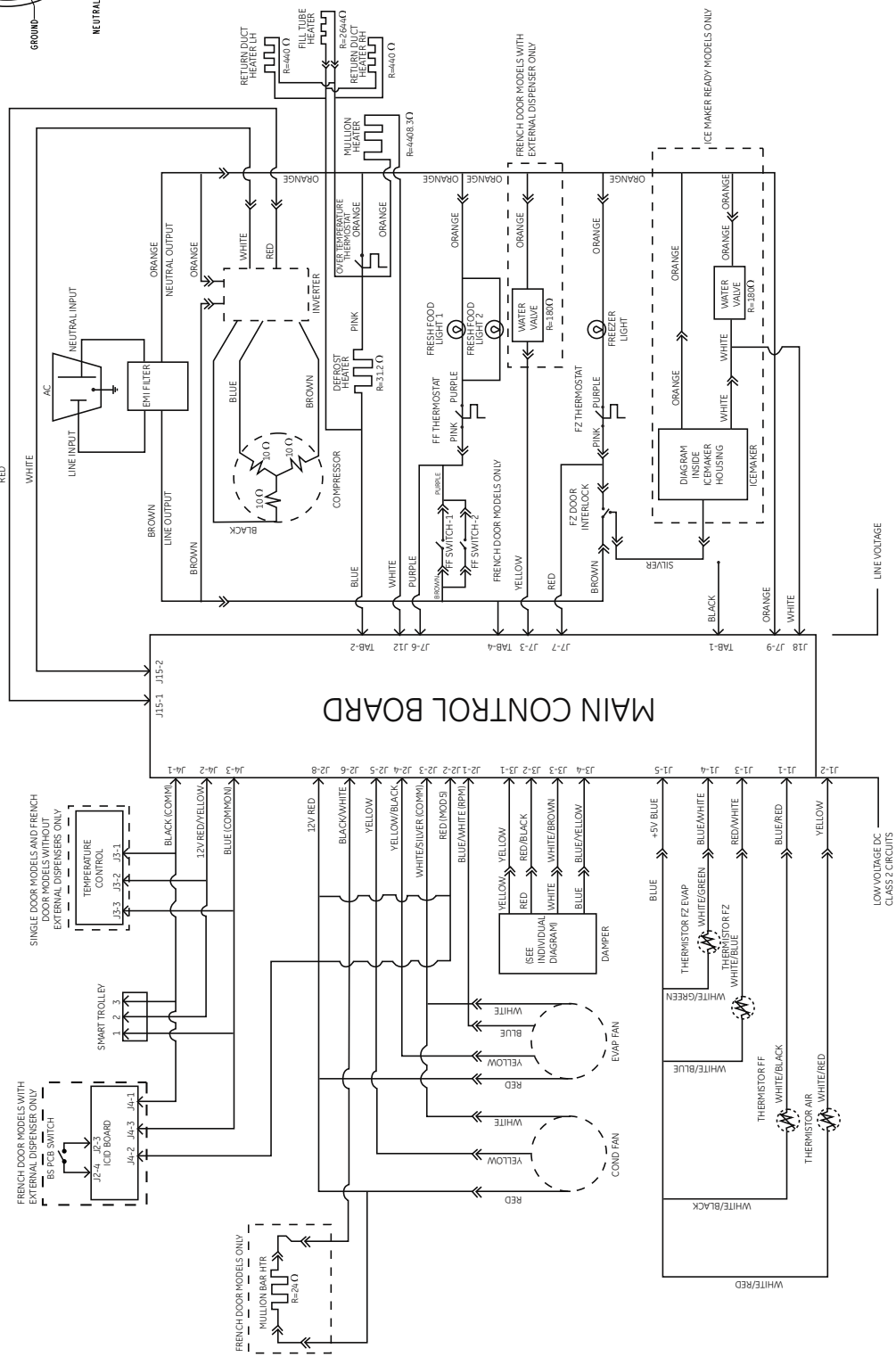

Note: 21' and 25' models have the white wire of the water valve connected to the main board at J18. The main board senses the water valve turning on and then runs the evaporator fan for 120 minutes. If the water valve cycles again in 120 minutes, the timer is reset to count another 120 minutes. Otherwise the fan will cycle off and on in a normal mode. This logic provides increased ice production.

Warranty

Refrigerator Warranty. (For customers in the United States)



All warranty service provided by our Factory Service Centers, or an authorized Customer Care® technician. To schedule service, on-line, 24 hours a day, visit us at ge.com, or call 800.GE.CARES (800.432.2737). Please have serial number and model number available when calling for service.

Staple your receipt here.
Proof of the original purchase date is needed to obtain service under the warranty.

For The Period Of: GE Will Replace:

GE and GE PROFILE MODELS:

One Year
From the date of the original purchase
Any part of the refrigerator which fails due to a defect in materials or workmanship. During this **limited one-year warranty**, GE will also provide, **free of charge**, all labor and related service to replace the defective part.

Thirty Days
(Water filter, if included)
From the original purchase date of the refrigerator
Any part of the water filter cartridge which fails due to a defect in materials or workmanship. During this **limited thirty-day warranty**, GE will also provide, **free of charge**, a replacement water filter cartridge.

GE PROFILE MODELS ONLY:

Five Years
(GE Profile models only)
From the date of the original purchase
Any part of the sealed refrigerating system (the compressor, condenser, evaporator and all connecting tubing) which fails due to a defect in materials or workmanship. During this **limited five-year sealed refrigerating system warranty**, GE will also provide, **free of charge**, all labor and related service to replace the defective part in the sealed refrigerating system.

What GE Will Not Cover:

- Service trips to your home to teach you how to use the product.
- Improper installation, delivery or maintenance.
- Failure of the product if it is abused, misused, or used for other than the intended purpose or used commercially.
- Loss of food due to spoilage.
- Replacement of house fuses or resetting of circuit breakers.
- Damage caused after delivery.
- Replacement of the water filter cartridge, if included, due to water pressure that is outside the specified operating range or due to excessive sediment in the water supply.
- Replacement of the light bulbs, if included, or water filter cartridge, if included, other than as noted above.
- Damage to the product caused by accident, fire, floods or acts of God.
- Incidental or consequential damage caused by possible defects with this appliance.
- Product not accessible to provide required service.

EXCLUSION OF IMPLIED WARRANTIES—Your sole and exclusive remedy is product repair as provided in this Limited Warranty. Any implied warranties, including the implied warranties of merchantability or fitness for a particular purpose, are limited to one year or the shortest period allowed by law.

This warranty is extended to the original purchaser and any succeeding owner for products purchased for home use within the USA. If the product is located in an area where service by a GE Authorized Servicer is not available, you may be responsible for a trip charge or you may be required to bring the product to an Authorized GE Service location for service. In Alaska, the warranty excludes the cost of shipping or service calls to your home.